

# KEYNES CONTROLS Ltd

Model VibWire-201-Pro

## Vibrating Wire Sensor Analyser & Data Recording Unit



Part No: VibWire-201-Pro

ADVANCED FFT SENSOR ANALYSER

PRECISION TEMPERATURE READINGS

USER PRESET VW SENSOR CONFIGURATIONS

SDI-12 & RS-485 REMOTE COMMUNICATIONS

DAYLIGHT READABLE LCD DISPLAY

DATA LOGGING TO MICRO SD MEMORY CARD  
UP TO 32 GB STORAGE

SPREADSHEET FORMAT DATA FILES

REAL-TIME CLOCK

EXPANSION OPTIONS  
- 16 X 4 WIRE INPUTS  
- 32 X 2 WIRE INPUTS

## Features

Lightweight, Portable & Rugged  
Compatible with most manufactures vibrating wire sensors  
Real-time displays Freq (Hz), Digits (Hz<sup>2</sup>/1000), SI-Units, Spectra  
FFT Spectral based algorithms for interference free measurements  
Auto-resonance Excitation 400 - 15 KHz range - Minimises Sensor Stress  
Fully configured sensor operations  
Large data storage - 100 million readings - SD Flash Cards to 32 Gb  
Fast Data Recording - 1 sec to 1 hour logging intervals  
No Vibrating Wire Sensor prior operating conditions required  
Expandable to 16 x 4 Wire / 32 x 2 Wire (Frequency or Temperature)  
SDI-12 and RS-485 ports for remote network connection  
Optional radio interfaces for cable free operations  
20 User Defined Sensor Types  
200 Programmable Sensors for Site Surveys  
Unlimited Site Projects  
Free Windows Configuration Software



## Benefits

Out the box solution for vibrating wire sensor measurements  
Daylight readable LCD Display  
Customised FFT-based algorithm ensures readings are accurate and free from interferences  
Real-time Sensor Spectra Display  
No special cables or connectors required  
No programming experience required to interface to 3rd party loggers and data acquisition systems..  
Stand-alone & PC Data Recording Capability.  
High Resolution—less than 0.001 Hz (industry standard is 0.1 Hz)  
Low power consumption - Uses readily available AA battery life - 24 Hours continuous use  
Suitable for laboratory testing and field measurement applications  
Works with all RTD-temperature sensors regardless T0 resistance - 3 K, 10K etc  
Free Data Storage and Display Applications Software

## Additional items commonly used with the VibWire-201-Pro Unit

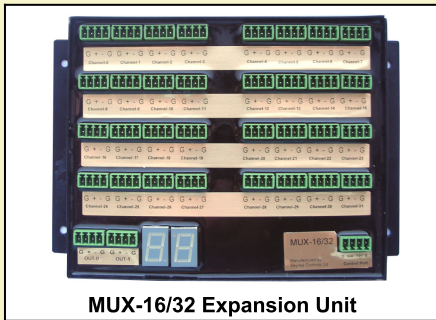

**MUX-16/32 Expansion Unit**



**USB-SDI12-Pro Media Converter**



**USB-485-Pro Media Converter**

This device is used to expand the number of sensor inputs that can be used by the VibWire-201-Pro from a single channel to 32 inputs.

This device can be powered directly from the VibWire-201-Pro for stand-alone measurements.

This device is used to connect the VibWire-201-Pro to a Windows PC remotely across the SDI-12 digital network. The USB-SDI12-Pro can be used to power the VibWire- 201-Pro for fixed monitoring applications

The device supports all of the Keynes Controls SDI-12 sensor and interfaces, including many 3rd party devices.

The USB-SDI12-Pro isolates the network devices from the Windows PC USB port and protects it against possible damage caused by sensor failures.

This device is used to connect RS-485 based intelligent devices including the VibWire-201-Pro a Windows PC.

The device not only can power sensors on the network, but also isolates the PC USB port from any possible device failure in order to prevent damage to the host PC.

The device supports all of the Keynes Controls RS-485 sensor and interfaces, including many 3rd party devices.

## Youtube Demonstration Video

A demonstration of the device can be seen at:

<https://youtu.be/6dAL9LGOPj0>

Filename: **VibWire-201-Pro.mp4**

## Applications Software

The VibWire-201-Pro is set up using the VW201Cal applications software.

This software can be downloaded at: <http://www.aquabat.net/downloads/VW201CAL.zip>

And also found on the SD Flash memory card



VibWire-201-Pro demonstrating the ability to calculate and display a real-time vibrating wire sensor spectra.



### Product Changes

Keynes Controls Ltd has an on-going policy of design review and reserves the right to amend the design of their product and this instruction manual without notice

## Downloading and Installing device setup software

1. Download the VW201cal software from:

<http://www.keynes-controls.net/downloads/VW201cal.zip>

Run the install software script.

Follow the on-line instructions to install and activate the software.

Once activated the main Window shown in Fig 26 above will be displayed

### IMPORTANT NOTE

The VibWire-201-Pro fails to connect to the USB port of a Windows PC then the most common cause is a failure is that the device FTDI chip set driver has not been loaded into the operating system.

Microsoft accredited FTDI chipset device driver can be found at: <http://www.ftdichip.com/Drivers/VCP.htm> (VCP - Virtual Com Port)  
- Windows Version 2.12.24 (Oct 2016)

Installation Guide for the FTDI driver installation can be found at: <http://www.ftdichip.com/Support/Documents/InstallGuides.htm>

### Q-LOG Data Acquisition & Display Software

The Q-LOG software provides the User with a Windows interface to the VibWire-201-Pro. Measurements can be recorded directly to a PC and displayed to the screen in the form of charts and panel meters.

Download a copy of the Q-LOG software at: [http://keynes-controls.com/Download/QLogSetup50\\_21may2020.zip](http://keynes-controls.com/Download/QLogSetup50_21may2020.zip)

## Important Notes - Sample Rates

In stand-alone operation the sensor measurements are made at a rate of 1 sample/sec,

When used as a data recorder with the MUX-16/32 expansion unit, the VibWire-201 requires approximately 2 Seconds/Chan to make a reading.

16 x 4 Wire Operation - Fastest sample Rate 30 Seconds.

32 x 2 Wire Operation - Fast sample rates are 1 minute.

## Factory Default Setting Reset

Select the 'Reset Defaults' option shown below to reset the device to its factory settings. The image below shows the menu operations required to undertake this task. The default SDI12 and RS485 network ID = 0.

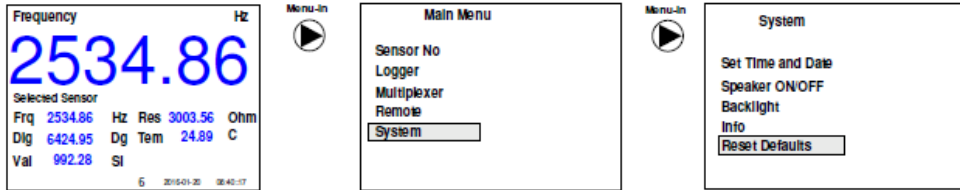

Fig 1

## Data Storage

The VibWire-201 stores measurement data in CSV (Comma Separated Variable) Txt format direct to the SD card.

### Micro-USB Port (Type B)

The micro-USB port is used to configure the VibWire-201-Pro and to download data. Use the VW201pro configuration software tool to assign sensor configuration information into the instrument.

### SDHC Flash Memory

The VibWire-201-Pro supports a single SDHC memory card slot. The memory card has to be pre-formatted before use.

The maximum size memory card currently supported is 32 Gb.

## Data Storage to the SD Memory Card

The VibWore-201-Pro can store reading directly onto a flash memory card that can be installed into the unit.

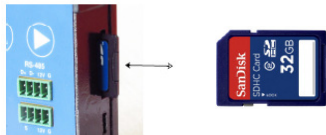

Fig 1A

1. Insert a flash memory card into the VibWire-201-Pro. Make sure the device is DOS formatted before use.

This operation can be carried out on any PC or laptop.

### Memory Card Type

The VibWire-201-Pro requires SD type flash memory cards. SD cards are usually 4 GB storage size or above.

### SD Card - Error Message

Do not use MMC type flash cards, even though same physical size as SD type memory cards since they will not work in this unit.

NO SD – this can appear on the display to indicate that the wrong card type has been installed into the unit.

MMC type cards typically have storage capacity of 256 Mb to 4 Gb

Once the recording interval is set the VibWire-201-Pro will commence recording measurements to the flash memory card.

### Removing the Memory Card

Using a small amount of applied pressure to the flash memory card. Push the card into the device to release it from the holder.

The card will now be ejected from the VibWire-201-Pro and can be read using a PC or another reading device supporting the DOS file system. The data stored on the card is in CSV (Comma separated format) and can be read by spreadsheet and similar software. As soon as the card is removed the data logging



# Features



1. **Rubber Protective Boot Cover**
2. **Sensor FFT Spectra**
3. Menu-In & Power On/Off Button Press and hold for 2 seconds the "Menu Out" button. The device will be displayed. Repeat the Operation to power off the device.
4. **MUX-16/32 Control Port**
5. **Menu-Out On On/Off Button**
6. **Sensor Port - 4 Wire Input**  
Compatible with the VW301 & VW108 units.
7. The Vibwire-201 Pro uses 4\*AA cells to power the device. These are available from many sources and can be easily swapped on site.
8. **Vibrating Wire Sensor.**
9. **ABS Plastic Reinforced Enclosure**
10. Daylight Readable LCD Display
11. **Backlight - LCD Screen** Options for High, Low, Off.
12. **User Defined Sensors - 200 options**  
Use the Windows Configuration software to assign sensor details.
13. **Temperature Sensor.**  
Automatic temperature sensor configuration. Supports most 3rd party sensors.
14. **Menu Control Buttons**  
Use the Menu-in and Menu-Out buttons to select the different menu systems.
15. Use the 'Up' and 'Down' menu keys to select the menu items.
16. **RS-485 Network Port**
17. **SDI-12 Network Port**
18. **4 Wire Sensor Inputs + Earth ( Spring Terminal Post )**

The LCD display is clear to read in most lighting conditions. A back light is available for low level light environments. Three levels of display brightness can be 'User assigned'.

The 4 wire sensor port mounted at the bottom of the instrument uses a general sensor connection port. Bare sensor wires can be simply connected directly into the spring terminal posts.

19. **Earth.**
20. **Frequency Port**
21. **Temperature Port**

## 24. Optional Protective Waterproof Case

Keeps the device safe while travelling and on site and stores all the accessories for easy use.

## 25. Spare Batteries ( 4 X AA )

26. **micro-USB cable** for Device Configuration
27. Spare Flash memory card storage

## Quick User Guide

The instructions shown in the Quick User Guide presumes that the batteries have already been installed into the device and a vibrating wire sensor is ready for testing. The VibWire-201-Pro will operate with any sensor manufactured device.

The VibWire-201 comes pre-configured with default temperature sensor calibration factors defined. The preset temperature sensor calibration factors are based on a 3 K Ohm @ 25 Deg C device. The following sensor part numbers all use the same calibration settings.

## Default Thermistor Part Numbers

YSI 44005  
Vishay 1C 3001 B3  
RS Part no: 151-215

## Automatic Time-out

The VibWire-201-Pro will power down automatically after 30 minutes of unattended operation, unless configured to make measurements.

## Power On The VibWire-201-Pro.

## Connecting a Sensor to the Device

Connect a single sensor to either the 5 pin terminal block input port or directly onto the sensor port mounted at the bottom of the device using the spring loaded terminal posts. See device ports on page 5.

Connect the sensor frequency output to the red and black spring post.

Connect the temperature sensor to green and yellow signal posts.



Fig-4 Frequency Input Signal Connection



Fig 5 Thermistor Input Signal Connection

## Real-time Results

As soon as the vibrating wire sensor is connected to the VibWire-201-Pro then the measurements will be displayed on the display.

Fig 6

4. Use the 'Up' and 'Down' keys to switch between **Hz**, **Digits** and **Spectra**.

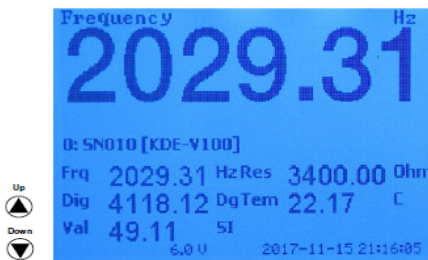

The SI unit display remains blank until configured.

## Storing the menu option

Once the selected menu option is highlighted simple **Menu-Out** press the button to store the new option.



Repeat the operation until the '**Frequency**' display appears.

See Fig 15 page 8.

## Adjusting the display

Use the keyboard 'Up' and 'Down' arrow keys to adjust the results display screens. The main display can be set to show sensor frequency in Hz, Digits, SI Units and Spectra. The display screen will be changed as the Up and Down keys are pressed.

1. Menu-Out
2. Down
3. Up
4. Menu-In

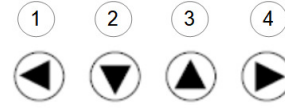
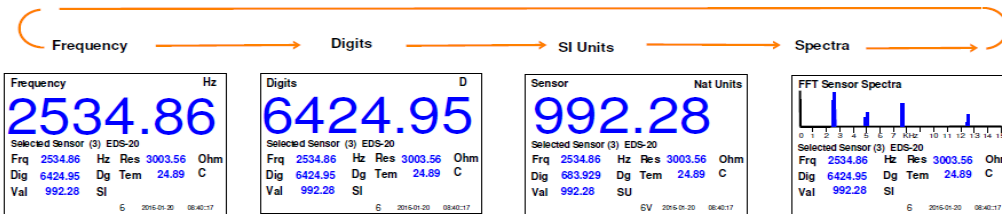

Fig-7



Use the Up Key '2' and Down key '3' to change the display screen.

The results shown above are obtained using an Encardio-rite EDS-20 vibrating wire pressure sensor

## VW Sensor Installation

The VibWire-201-Pro supports full 4 wire sensor operations. The device measures frequency and temperature from any suitable vibrating wire sensor.

Connect a Vibrating Wire sensor to the 5 pin 'Sensor Input' port or directly to the spring return termination posts mounted at the bottom of the unit.

1. Connect the sensor coil to the 'Frequency Input' port.
2. Connect the sensor thermistor (temperature) sensor to the 'Temperature Input' port.
3. Use the **VW201cal.exe** software to define thermistor calibration factors.

Figure 8 shows how to connect a 4 wire vibrating wire sensor to the spring loaded terminal posts..

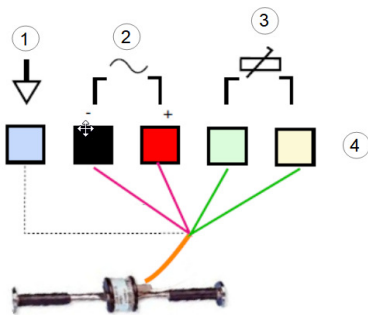
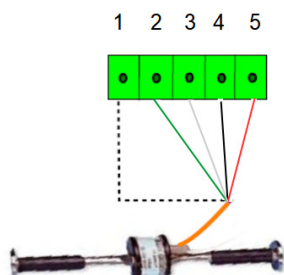

Fig 8

Figure 9 shows how to connect Vibrating Wire Sensor connection to the device Sensor Port - See image page 5 item 6.

### Sensor Port



1. Sensor Screen / Earth
2. - VW Sensor Input
3. + VW Sensor Input
4. - Temperature Sensor Input
5. + Temperature Sensor Input

Fig 9

### 4 Spring loaded Sensor Signal Posts - See (Page 5 item 18)

	Description	Sensor Post Colour
1	Earth / Screen	Blue
2	Frequency Input	Red (+) Black (-)
3	Temperature Sensor	Thermistor (+) Thermistor (-)

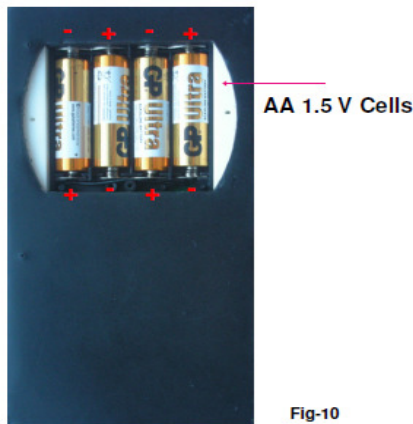

Fig-10

## Fitting Batteries

Only fit standard AA batteries in the VibWire-201-Pro.

1. Remove the battery cover from the rear of the device by simply unscrewing the securing bolts.
2. Replace the battery set in the layout shown in the image opposite.
3. Replace the battery cover and power on the unit.

The battery level indicator will show **6V** when a new set of batteries has been installed.

## Battery Life

When operating as a single channel device using a new set of batteries the VibWire-201-Pro will operate for approximately 24 Hours continuous use.

### IMPORTANT NOTE

Remove the batteries from the VibWire-201-Pro should the device not be used for a long period of time

## Low Battery Level Effects

Once the battery levels falls before 4.5 V then

1. Display may not update at the correct rate and appears to flicker.
2. Measurement values can be erratic.

Once the display falls below 4.5V then the 'Low Battery' indicator flashes, see Figure 13 below. Should the unit continue to operate then the display may flicker. Fit a new set of batteries.

## External Power Supply

For long term monitoring applications an external power supply can be fitted onto the VibWire-201-Pro.

The external power supply is applied to the +12 V and Gnd (G) pins on the SDI-12 and RS-485 ports.

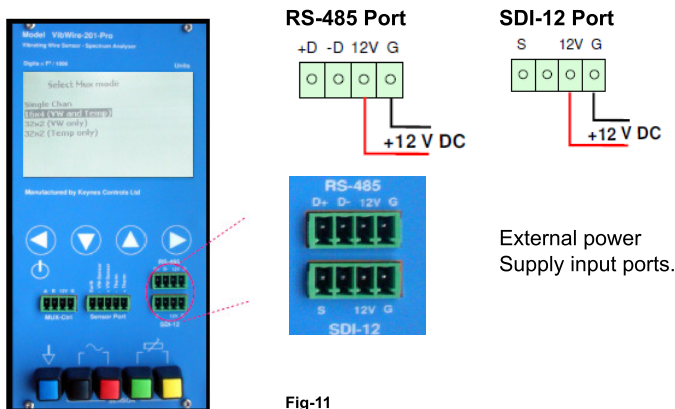

Fig-11

The VibWire-201-Pro only acts as a slave device when connected onto a digital network. As such the external power supply only powers the device and no other device upon the network.



## Setting the Real-time Clock

The real time clock in the VibWire-201-Pro is configured using the **'Set Time and Date'** menu, See Figure 12 below.

See Page MM for details on selecting the 'Time and Date' menu.

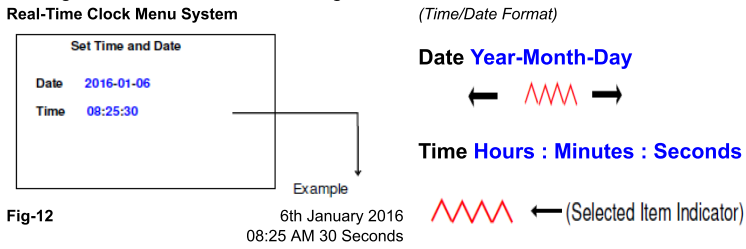

Use the Up and Down keys between **'Date'** and **'Time'** options.



Select Date or Time to be configured

Use the **'Menu-Out'** and **'Menu-In'** keys to move along the Date or Time fields.

As the keys are pressed the  item indicator symbol will be displayed under chosen item.

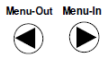

Once the parameter to adjust has been chosen then use the **'Up'** and **'Down'** buttons to make changes.

The **'Up'** and **'Down'** buttons will increment, or decrement a parameter by 1 unit after each action.

### Adjusting the Date

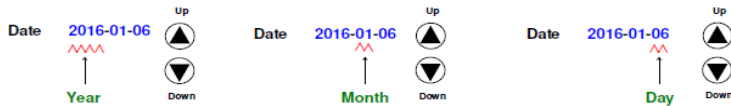

### Adjusting the Time

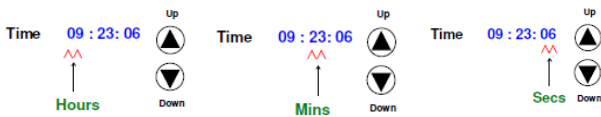

Move through each date and time parameter in turn making adjusts as necessary.

## Saving New Clock Parameters



Once all parameters have been set, press the  button until the default **'Frequency'** menu is displayed.

The new date and time values will be stored and the real-time clock settings updated to the different menus.

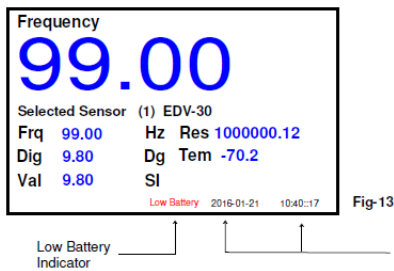

Fig-13

Date and time string will update with the new settings.

### Note

The **VW201cal.exe** Windows configuration software automatically sets the time and date used by the VibWire-201-Pro to the PC clock.

## Automatically setting the Real-time Clock

The VibWire-201-Pro can be used as a stand-alone VW sensor data logger recording measurements automatically, and also to take single shot readings under 'User' control. In order to act as a logger the internal real-time clock has to be set.



The real-time clock is used to keep track of the time and date of a measurement. The clock is set automatically the VibWire-201-Pro is connected to the PC via the USB cable and the 'Upload' button is activated. Once the sensor data is written into the device then the clock is automatically synced to the host PC

## Real-time Results Display Parameters

Figure 14 below shows the parameters that are shown on the results screen.

**Important Note**

Use the 'Up' and 'Down' arrow keys to switch between the different results screens.

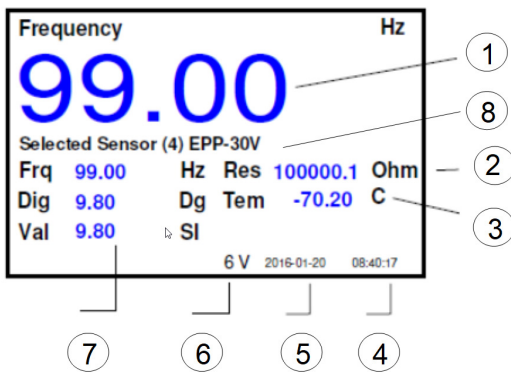

Fig 14

1. Fundamental Frequency (Hz).
2. Temperature Sensor Resistance (Ohms).
3. Temperature in Deg C.
4. Date.
5. Time.
6. Battery Voltage
7. SI Units (mm, pressure, micro-strain)
8. Sensor Type.



Use the Arrow keys to change the device results screen.

## Pre-defined Thermistor Calibration Parameters

The VibWire-201-Pro uses the following predefined calibration parameters to define the operation of the 3 K Ohm thermistor temperature sensors built into most Vibrating Wire sensors.

### (Steinhart-Hart Factors)

A = 3.35E-3, B = 2.56E-4, C = 2.08E-6, D = 7.30E-8

## Results Display

The images below show the real-time results screens available with the device.

The User can set the device to show results in Hz, Digits, SI Units and Spectra.

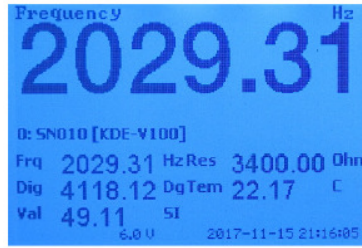

Frequency Results in Hz - Temperature in Deg C  
Fig 15



Press the 

keys to simply move through the different results screens. As the menu keys are selected the results displays will change Units automatically.

### Frequency to Digits

Press the **Down** to move from Hz to Digits



Frequency Results in Digits - Temperature in Deg C  
Fig 16



### Digits to SI Units

Press the **Down** to move from Digits to SI Units



### SI Units to Sensor Spectra

Press the **Down** to move from SI units to Spectra



#### Import Note:

The sensor spectra shows a good clean signal with very high signal to noise.

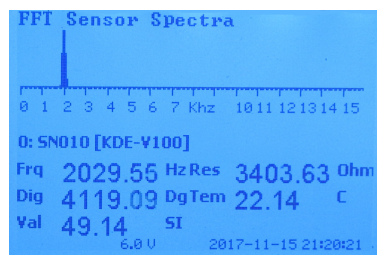

Sensor Spectra- Temperature in Deg C

Fig 18



## Selecting Remote Network Connections

The VibWire-201-Pro unit can connect to the SDI-12 and RS-485 networks for use in remote vibrating wire sensor measurements. The SDI-12 and RS-485 ports enable the VibWire-201-Pro to transmit sensor data into third party data logger and acquisition systems.

### Device Port Selection

To select the network port type for remote data acquisition operations on the VibWire-201-Pro, use the menu system to select either of the menu items shown below. The device will then make measurements, and transmit data over the specified network port.

Page 30 shows the menu system built into the VibWire-201-Pro.

#### SDI-12 Port Selection Menu

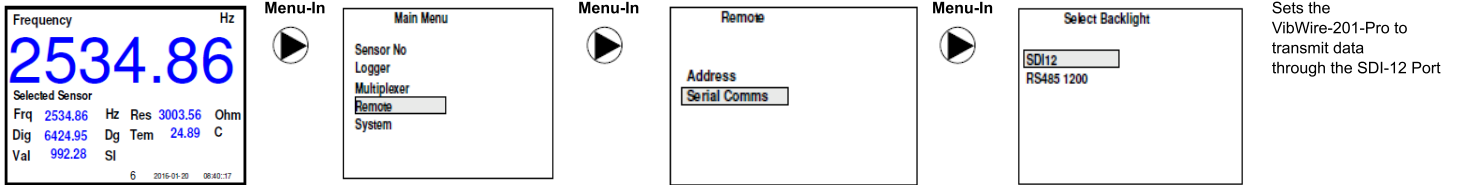

Fig 19

#### RS485 Port Selection Menu

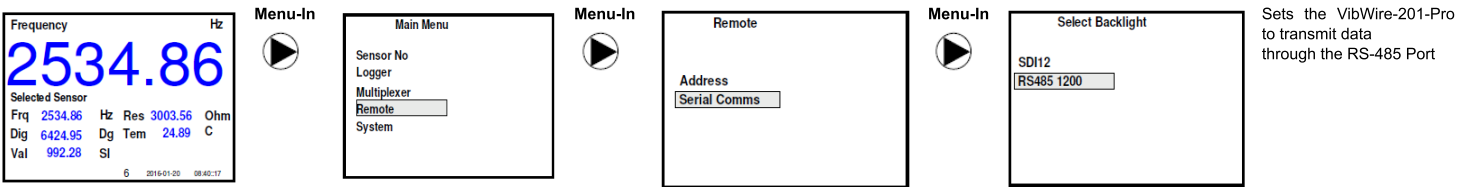

Fig 20

For single channel operation, once the output port is specified the sample data can be shown on the display.

#### Storing the menu option

Once the selected menu option is highlighted simply press the **Menu-Out** button to store the new option.



Repeat the operation until the 'Frequency' display appears. See Figure 15 on page 8.

#### SDI12 Remote Port

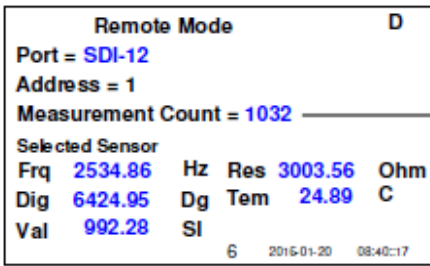

Fig 21

1032 measurements since the start of the data recording operations. Device has ID = 1. **RS485 Remote Port Operation**

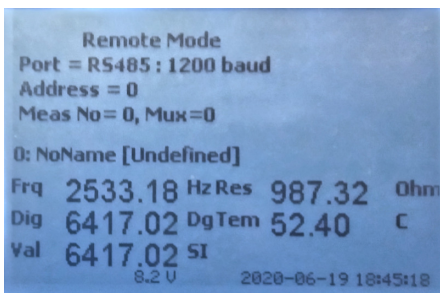

Fig 22

Fig 22 opposite shows the RS485 remote network results screen.

## Technical Specification

The current technical specification for the VibWire-201-Pro is:

<b>Description</b>	
Physical Size (Excluding boot cover)	Height 184 mm - Width 74 mm - Depth 32 mm
Weight	125 g
Battery	4 x AA - 2000 mA/Hr
Auto-logging no backlight	6 mA - standby - 340 Hours continuous use 20 mA/Hr with display - Low 50 mA/Hr with display mode - Full brightness 150 mA/Hr with MUX-16/32 - Peak (Note-1)
Communication Ports	1 x RS-485 Slave - 1200 Baud, 8 data, 1 stop, no parity 1 x SDI-12 - 1200 Baud, 8 data, 1 stop, no parity 1 x micro USB configuration port
External Power Supply	10 - 15V DC @ 100 mA min specification
<b>Vibrating Wire Measurements</b>	
Analogue Input	24 Bit Sigma Delta Differential Coil (V+) and Coil(V-) for direct connection of sensor, excitation and resonant frequency measurement. Digital signal processing for excellent noise rejection, Auto-resonance - Fully automatic
Sensor Excitation	400 - 15 KHz
Operating Frequency	0.001 Hz RMS - 20 to 70 Deg C
Measurement Resolution	± 0.014% of reading - 20 to 70 Deg C
Measurement Accuracy	1024 line Zoom FFT - with data weighting
Spectral Analysis	0.001 Hz
Resolution	Hamming
Window Function	0.25 Sec typical
Update Rate	Hz, Digits (Hz <sup>2</sup> /1000), Eng Units (Quadratic Cal Factors)
SI Units	Used for temperature compensated vibrating wire measurements
<b>Temperature Measurements</b>	
Analogue Input	24 Bit Sigma Delta
Measurement Range	- 50 to 100 Deg C
Measurement Accuracy	± 0.25 % of reading - 20 to 70 Deg C
SI Units	Deg C
Cal Factors	Steinhart-Hart Beta Value - lower performance using Beta
Bridge Type	Half Bridge
Expansion Options	1..32 - 2 Wire Freq inputs 1..32 - Temp (thermistor) inputs 1..16 - 4 Wire vibrating wire sensor inputs 2 Sec/Chan - using MUX-16/32 expansion module
<b>1 x MUX-16/32 expansion unit</b>	250 ms update to screen
<b>Scan rate</b>	1 x SD Card = 1 .. 32 GB
Memory Expansion	
Storage file format	CSV - Comma Separated Variables
Logging Rates	Internal to flash card 1s, 10s, 1 Min, 10 Min, 1 Hour, 6 Hours MUX-16/32 Expansion
16 x 4 Wire Mode	30 Sec/Chan
32 x 2 Wire	1 minutes
<b>No. Pre-set Sensor Configurations</b>	10 user defined sensors options
File Type Format	DOS
Operating Temp Range	-20 to 75 Deg C
Storage temperature	>5 Deg C with batteries installed.

Table 1

Note-1 - Use external supply for long term monitoring with MUX-16/32 unit 150 mA peak .

## Associated Part Numbers

<b>VibWire-201-Pro</b>	- FFT VW Sensor Interface
<b>USB-485-Pro</b>	- Isolated USB to 485 media converter
<b>USB-SDI12-Pro</b>	- Isolated USB to SDI12 media converter
<b>MUX-16/32</b>	16 x 4 Wire/ 32 x 2 Wire Expansion unit

## Device Configuration Software

The VibWire-201-Pro configuration software runs on most modern Windows platforms such as XP, 8.1 and 10 operating systems.

The software automatically identifies the USB port in use and allows for a true plug and play operation. Simply enter the sensor calibration factors and select the 'Connect' button to store parameters into the device.

<http://www.keynes-controls.com/downloads/VW201cal.zip>



## SDI-12 Network Connection

Figure 24 below shows how to connect the VibWire-201-Pro SDI-12 port to the USB-SDI12-Pro media converter. Any suitable 3rd party media converter can be used with the device.

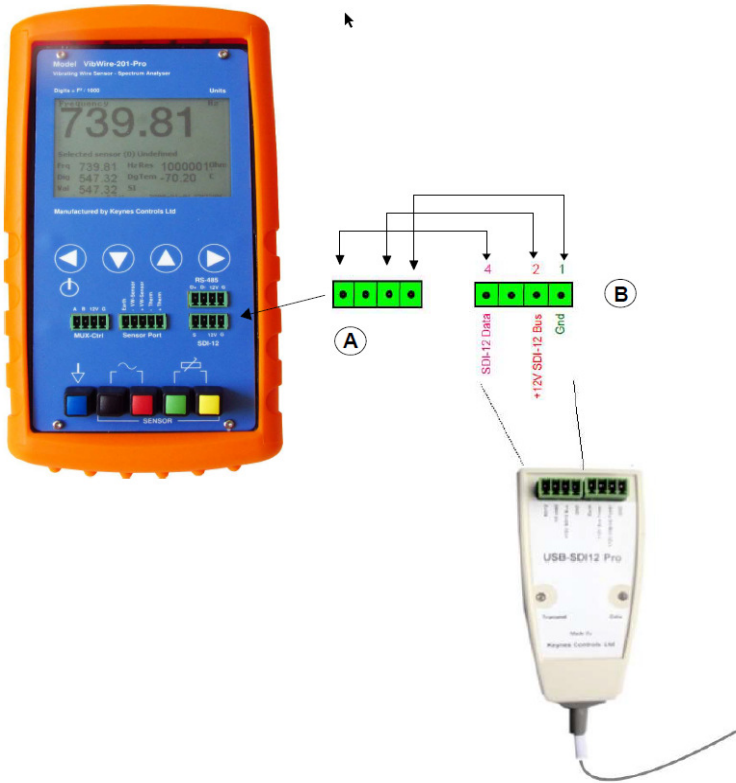

Part No: USB-SDI12-Pro

## RS-485 Network Connection

Figure 23 opposite shows how to connect the VibWire-201-Pro RS-485 port to the USB-485-Pro media converter. Any suitable RS485 media converter can be used with this device.



Part No: USB-485-Pro Fig 25

## USB Media Converters

The Keynes Controls manufactured USB to SDI12, and RS485 media converters are opto isolated devices. They protect the PC USB port from any sensor or network failure.

The media converters make it easy to communicate from the device to a Windows PC.

### Device ID Number

The VibWire-201 must have a device ID number assigned for SDI-12 and RS485 remote network data transmission.

The menu options for assigning the device ID number can be seen on page 35, figure 65.

The ID number is the same for both the SDI-12 and RS485 network



Table 2 - SDI12 Network Connections

Port A - Device SDI125 Port	Port B - (USB-SDI12-Pro)
Pin-4 SDI12 Data	Pin- 4 SDI012 Data
Pin-3 No Used)	Pin-3 Not Used
Pin-2 +12 V DC	Pin-2 +12 V DC
Pin-1 Gnd	Pin-1 Gnd

The VibWire-201-Pro can be connected to the SDI-12 network like any other type of intelligent sensor, and use this network to transfer measurements to a PC or data recorder.

The VibWire-201 is fully integrated into the Keynes Controls Q-LOG software enabling test systems and recording applications to be created.

From the 'Select Serial Comms' screen select 'SDI12' option. See Fig 23 below.

Table 3 RS485 Network Connections

Port A - Device RS485 Port	Port B - USB-485-Pro
Pin-4 +D (RS485)	RS485 +
Pin-3 -D (RS485)	RS485 -
Pin-2 +12 V DC	+9 to 16V Out
Pin-1 Gnd	Gnd

The VibWire-201 supports RS485 network operations and can be used as a remote vibrating wire sensor interface. The device should be externally powered for operation on the RS485 network.

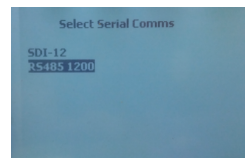

Fig 23 RS485 Network Selection

For remote data transmission across the RS485 network.

From the 'Select Serial Comms' screen select 'RS485' option. See Fig 23 above.

## Temperature Measurements

The VibWire-201-Pro is factory set to use the most common thermistor calibration factors that are fitted into most manufactures vibrating wire sensors. The thermistor is used to measure temperature.

The thermistor calibration factors are taken from the sensor manufactures data sheet and are as accurate as possible.

The voltage input measurements are factory calibrated to traceable national standards, and can be externally calibrated upon request. There is an extra charge for operation.

## Common VW Sensor Thermistor Part Numbers

YSI 44005  
Vishay 1C 3001 B3  
RS Part no: 151-215

The part numbers are for 3 K Ohm thermistor commonly used by most different VW sensor manufacturers to measure temperature  
The sensors give 3 K Ohm resistance at 25 Deg C  
The most common material used in these sensors uses material type F from GE sensing.

Under most practical applications, the in-built thermistor calibration factors will give accurate results without the User having to be concerned with understanding the process involved.

Simply connect the thermistor output from the sensor to the VibWire-201-Pro and the device will instantly display the temperature.

## Sources of Error

The principal source of error in field measurements will be the added resistance due to long sensor wires. The resistance added to the thermistor measurement will give a fixed offset error. Make temperature measurements as close to the temperature sensor as is practically possible.

## Calibration Factor Error

Take care when using the calibration factors supplied on a vibrating wire sensor manufactured data sheet. The factors are often given from sample sensors taken from a batch and not necessarily from the individual sensor being used. Where possible ensure that the sensor manufacturer calibrates the sensor and supplies all test data so that the calibration factors can be verified.

## User Defined Steinhart-Hart Calibration Factors

The VibWire-201-Pro has the facility to enter User defined Steinhart-Hart calibration factors.

The calibration factors are entered into the device using the VW201cal software package. See figure 27 on Page 16..

## Sensor Information

A calibration report should be provided with each vibrating wire sensor and it will contain all the information required to convert Hertz, the frequency value output by the sensor into appropriate SI units (e.g., displacement, pressure etc..)

1. If the values in the Calibration Report are in digits, use the following equation to convert the VibWire-201-Pro frequency values from Hertz to digits.

$$\text{Digits} = \frac{\text{Frequency}^2}{1000} \frac{(\text{Hz}^2)}{1000}$$

2. Use the gauge factors and polynomials provided in the Calibration Report to calculate SI units.

The VibWire-201-Pro uses:

$$\text{Natural Units} = \mathbf{A(R1)^2 + B(R1) + C + K(T1-T0) - (S1-S0)} \quad (\text{Equ 1})$$

Calibration equation.

and this is expanded to:

$$= \mathbf{C(R1-R0)^2 + B(R1-R0) + A + K(T1-T0) - (S1-S0)} \quad (\text{Equ 2})$$

when initial conditions in the measurements are involved.

The additional terms used in equation 2 only change the constant parameter ( A ) when used.

# Pre-set Sensor Configurations

The VibWire-201-Pro can be configured using the **VW201cal.exe** software which is available as a free download at:

<http://www.aquabat.net/downloads/VW201cal.zip>

## Features

The VW201cal software gives the User the ability to configure the VibWire-201-Pro in an easy to use Windows environment.

- Automatically sets time and date to host PC.
- Set the User defined frequency and temperature calibration factors.
- Select preset thermistor calibration factors.
- 20 Pre-set sensor configuration options.

The sensor names entered into the VW201cal software appear on the VibWire-201-Pro sensor list.

The VibWire-201-Pro supports up to 20 built-in User defined vibrating wire sensor configuration options.

## Sensor Configuration

$$SI \text{ Unit} = A + B(R1) + C(R1)^2 + D(T)$$

where R1 = Current Reading  
T = Temp Deg C  
D = Thermal Factor

Process Option

Thermistor Calibration Factors

0 = Frequency, 1 = Digits, 2 = SI Units

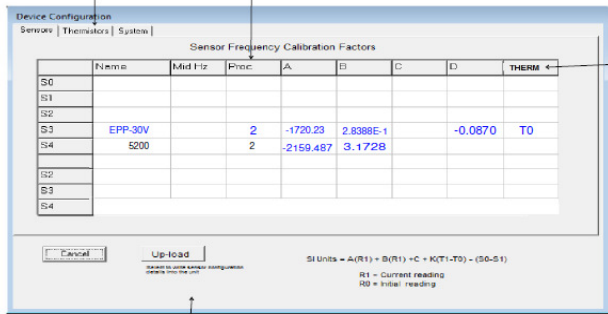

Thermistor Type T0, T1, T2 ..... Etc

Figure 26 opposite shows the VibWire-201-pro Setup software used for entering the calibration factors for a Vibrating wire sensor.

This Window is used to enter the frequency component calibration factors.

The calibration factors are used to enable the VibWire-201-Pro to display measurements directly in engineering SI units.

Write configuration details into the device.  
VW sensor calibration factors

Fig 26

## Device returns Data in SI Units

In order for the SI unit formulae be applied the process option has to be set to '2'.

In the example above the sensor with name 'EPP-30V' has the process option '2' and will record data to the SD card in SI Units.

Setting the process option to 0 or 1 shows results in Hz or Digits.

See Process Option in Fig 26 above.

## Select Thermistor Calibration Window

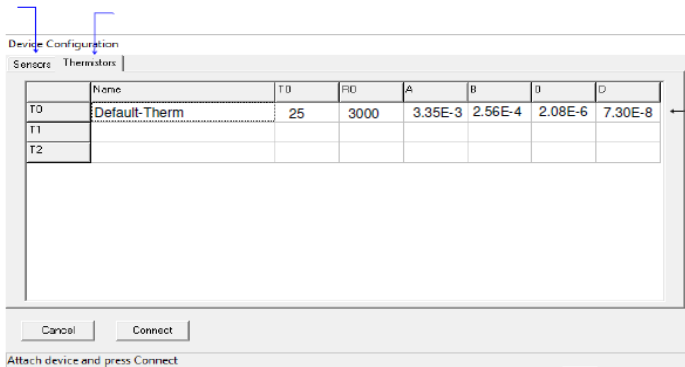

Default Steinhart-Hart calibration factors

Figure 27 opposite shows the thermistor calibration settings window for the **VW201cal** software.

The factory set default thermistor parameters for T0 are displayed.

When no temperature sensor calibration factors are available then select the 'Default-Therm' setting.

Fig 27 Default Thermistor Calibration Factors

## Frequently Asked Questions

1. What cable is used to connect the VibWire-201-Pro to a data logger.

A single 4 core ribbon cable is all that is required for the most common SDI-12 and RS-485. No special cabling is required for this instrument.

Farnell Website: <http://www.farnell.co.uk>

Farnell Part No. 150427

Manufactures Part No. 05091504-01-50M.

## 2. What might cause an VibWire-201-Pro to not communicate with a Data Logger?

There is no programming required for setting up and using the VibWire-201-Pro.

The most common cause for lack of communication is faulty wiring. Check that the cable cores are correctly terminated by the plugs. Use a DVM to test each core and pin on the plugs for continuity.

Make sure the correct network port is selected.

For SDI-12 and RS485 remote communications see the menu system screen in Figure 63 on page 45,.

## Network ID Number

Make sure the ID number used to identify the VibWire-201-Pro on a network is set correctly. See menu system on page 29 section 'Setting network address', or by the standard SDI-12 commands on page 20. A full list of User commands is shown on page 27.

The ID number for the measurement command used to acquire data from the VibWire-201-Pro must match the ID number set in the device.

Logger using command: 3M! 3D0! - then the ID number should be set to '3'.

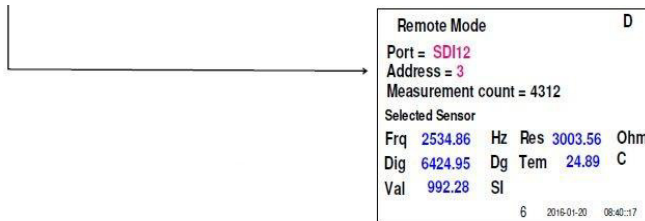

Page 30 shows the menu options to set the ID number.

### IMPORTANT NOTE

When multiple devices are being used on the same network, each device must have a unique ID number assigned. Failure to do so will prevent the VibWire-201-Pro from communicating to a logger unit.

## How fast can the VibWire-201-Pro make a measurement?

Currently the fastest data recording rate is 1 measurement / Second for a single channel.

The fastest sample rate is supported on the SDI-12 and 485 network measurements using the Q-LOG free data acquisition and display software, and to the in-built data recording to the flash memory card.

## Where Can I download a copy of Q-LOG software ?.

Download a copy of the Q-LOG software at: [http://keynes-controls.com/Download/QLogSetup50\\_21may2020.zip](http://keynes-controls.com/Download/QLogSetup50_21may2020.zip)

### Erratic Measurements - most common cause.

When the battery level goes below 3.9 Volts the measurements can become noisy and erratic. Replace the batteries in the unit for a new set, or connect an external power supply. Faulty sensor coil seating which can be seen in the sensor results spectra.

## How to make measurements on my PC without any programming experience.

Use the free issue Keynes Controls Q-LOG software that can be downloaded without restriction from the companies web site, and along with either a SDI-12 or RS485 media converter to communicate with a Windows PC. The VibWire-201 can be used as a remote sensor interface and communicates measurements to the PC. The Q-LOG software is used to store and display the sensor measurements.

See Youtube video link below demonstrating the Q-LOG software in operation with the VibWire-201-Pro :

## Channel Expansion Options

The VibWire-201 can be expanded using the MUX-16/32 expansion unit.

The device can be configured for 16 X 4 Wire and 32 x 2 Wire Operations.

The MUX-16/32 expansion unit is shown in Fig 28 below

Fig 28

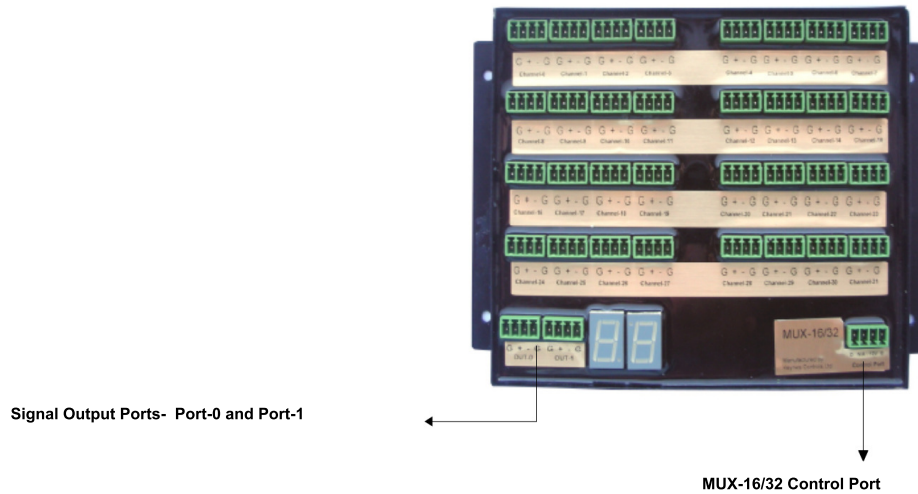

## MUX-16/32 Control Port

The control port is used by the VibWire-201 to select the output channel on the expansion unit.

Connect the Control Port on the VibWire-201 to that of the MUX-16/32 unit as shown in Fig 29 below.

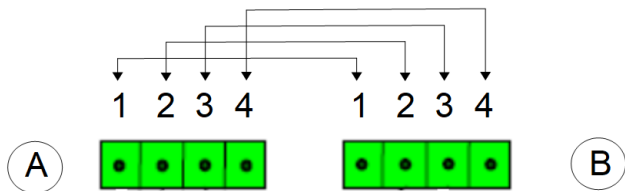

Fig 29

**A = MUX-16/32 Control Port**

### Pin-Outs

- 1
- 2
- 3
- 4

**B = VibWire-201 Ctrl Port**

### Pin-Outs

- |   |          |
|---|----------|
| 1 | A        |
| 2 | B        |
| 3 | +12 V DC |
| 4 | G        |

## MUX-16/32 Signal Output Ports

Fig 30 opposite shows the signal output ports on the MUX-16/32 Unit

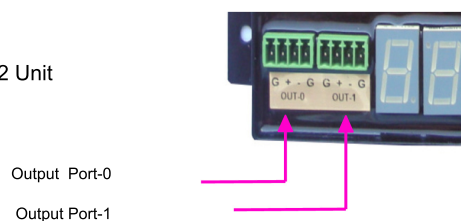

Fig 30

## MUX-16/32 Expansion Operations

The VibWire-201-Pro powers the MUX-16/32 expansion unit directly across the SDI-12 BUS and will reduce the battery life of the device if used without an external power supply.



## VibWire-201 to MUX-16/32 Sensor Connection

Connect the MUX-16/32 expansion unit to the VibWire-201 as shown in Fig 33A on page 19.  
 The expansion unit operation is defined by the device menu option as shown in figure 34 on page 20.  
 Refer to the image on Page 5 for the location and type of port on the instrument.

### Channel Expansion Options

The expansion options are:

- Single Chan
- 16X4 (VW and Temp)
- 32X2 (VW only)
- 32x2 (Temp)

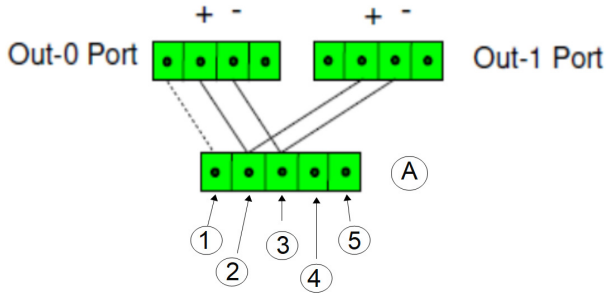

Fig 31

#### 32 X 2 Wire - Frequency

A = Device Sensor Input Port

- 1 = Gnd / Earth
- 2 = Frequency +
- 3 = Frequency -
- 4 = Not Used.
- 5 = Not Used.

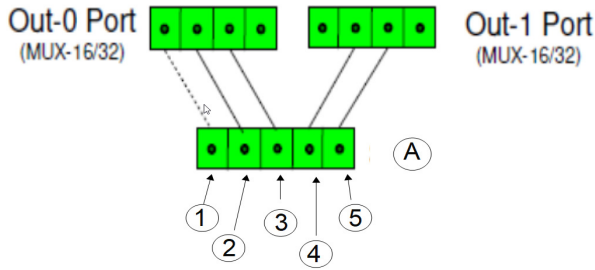

Fig 32

#### 16 X 4 Wire - Frequency and Temperature

A = Device Sensor Input Port

- 1 = Gnd / Earth
- 2 = Frequency +
- 3 = Frequency -
- 4 = Temperature +
- 5 = Temperature -

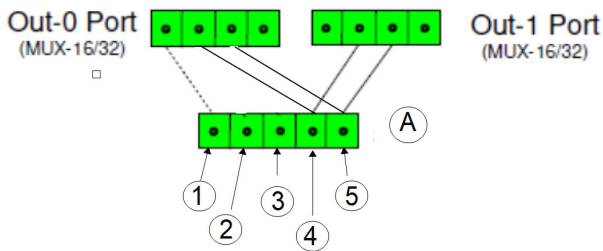

Fig 33

#### 32 X 2 Wire - Temperature

A = Device Sensor Input Port

- 1 = Gnd / Earth
- 2 = Not Used
- 3 = Not Used
- 4 = Temperature +
- 5 = Temperature -

Out-1 Port  
(VibWire-201-Pro)

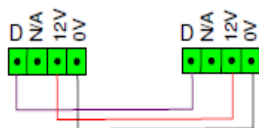

Control Port (MUX-16/32)

Wiring diagram for the MUX-16/32 control port to the VibWire-201-Pro

Fig 33A

## Number of Channels

The VibWire-201-Pro data supports 4 data recording modes:

**Single Channel** - Records measurements from the sensor attached directly to the instrument.

The following modes require the MUX-1632 expansion unit to be fitted:

## MUX-16/32 Expansion Unit

- 6 x 4 Wire (VW and Temp)** - 16 x Freq + 16 x Temp
- 32 x 2 (VW only)** - 32 x Freq
- 32 x 2 (Freq)** - 32 x Temp

when using the MUX-16/32 expansion unit 32 measurement values are stored into each record.

To select the data recording mode

1. Make sure a flash memory card is installed into the VibWire-201-Pro, See Page 5 Figure 2.
2. Starting at the default 'Frequency' display, use the '**Menu In**' key to select '**System Setup**' followed by '**Mux Mode**' menu options. The **Mux Mode** menu system will appear.
3. Use the '**Up**' and '**Down**' keys to select the mode of operation of the instrument.

### Setting Scan Mode

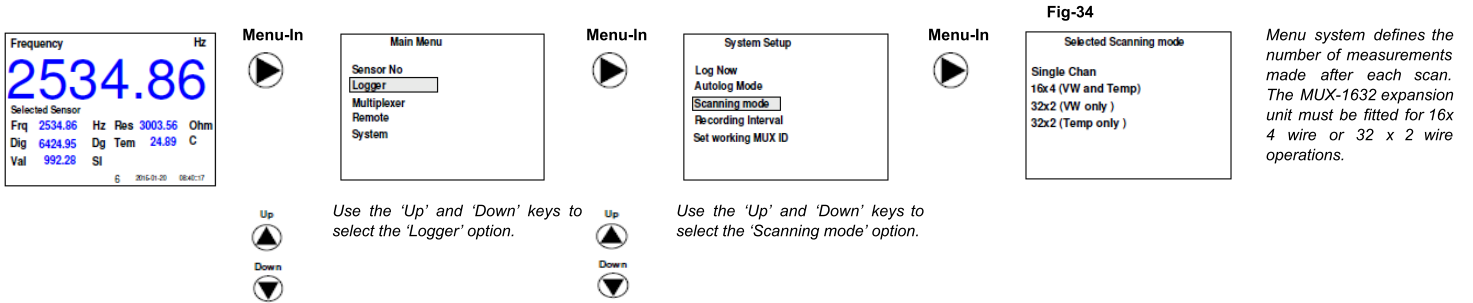

## Data Recording File Format and File System Type

The VibWire-201-Pro can store measurements directly on to a SD flash memory card.

Max SD Card = 32 Gb (160 million records)

DOS format file system.

The data table stores results in C.S.V. (Comma Separated Variable), for direct importing into spreadsheets such as Microsoft Excel.

## Data Recording Menu Options

The VibWire-201-Pro supports 3 x logging modes. Single Channel, 16 x 4 Wire and 32 x 2 Wire.

**Single Channel** - Continually records a single measurement from a sensor connected to the sensor port on the device.

- 1 x single measurement on demand.
- Single Channel on MUX-16/32 Unit.

Both the 16 x 4 Wire and 32 x 2 wire recording modes require the use of the MUX-16/32 expansion unit.

- 16 x 4 Wire** - 32 measurement values made up of 16 x Frequency + 16 x temperature.
- 32 x 2 Wire** - 32 x Frequency measurements.

**Important Note**

The VibWire-201-Pro will adjust automatically to the fastest sample rate allowed for the number of channels to be scanned.

The fastest sample rate that is allowed for a 32 channel operation is 60 seconds (1 min).

### Set Logging Interval

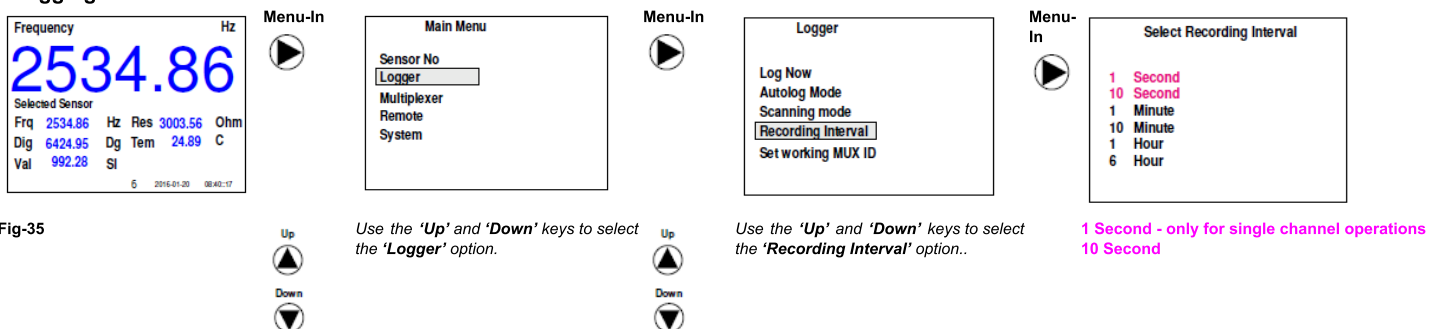

## Commands for scanning MUX-16/32 in 32 x 2 wire mode

Table 4 below shows the commands used to scan the MUX-16/32 unit in 32 x 2 wire mode. The Mode of operation is set via the menu system in the ViBWire-201 MUX Expansion option.

In 32 x 2 wire mode the channel counter displays the range 0 .. 31.



Start Measurement Command	Description	Channel Number	No. Data Values	SDI-12 Get Data Command
aM2!	MUX ID=0 Chan 0..15	Chan 0 .. 15	Returns 16 values x Freq	aD0! aD1! aD2! aD3!
aM3!	MUX ID=0 Chan 16..31	Chan 16 .. 31	Returns 16 values x Freq	aD0! aD1! aD2! aD3!

Each get data command returns 4 values.

Table 4

Fig-37

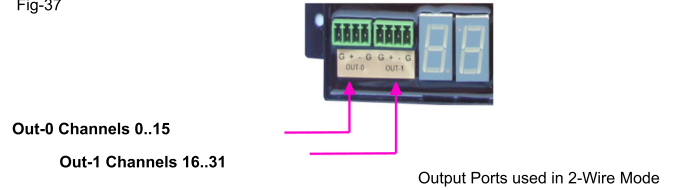

When operating in 2 wire mode, the VibWire-201-Pro scans the MUX-16/32 in blocks of 16 channels.

Under normal operating conditions Channels 0-15 are scanned first and the results stored into a data table. This is followed by scanning the final block of 16 channels and storing the measurements. Table 1 shows the sequence of the 2 blocks of commands needed to scan the MUX-16/32 unit in 2 wire mode.

## Switching between 2 & 4 Wire Mode Operation under SDI-12 Command

The MUX-16/32 expansion unit supports 2 and 4 wire VW sensor operations. The selection between 2 and 4 wire sensors is undertaken using software commands only and these are issued across the MUX-16/32 using the SDI-12 control port. The same procedure for issuing instructions for changing the ID number is followed as is used for selection of the mode of operation.

The following SDI-12 command selects 2 or 4 wire sensor operation:

aXDn! (n=0 or 1) Sets 2 or 4 wire operations on the MUX-16/32.

Example SDI-12 command '0XD1!' sets MUX-342 with ID=0 to 4 Wire mode.



## Commands for scanning MUX-16/32 in 16 x 4 wire mode

Table 5 below shows the commands used to scan the MUX-16/32 unit in 16 x 4 wire mode.

The MUX-16/32 unit has to be set to operate in 16 x 4 Wire mode. This is done via the VibWire-201-Pro setup menu.

In 16 x 4 wire mode the channel counter displays the range 0 .. 15.

Start Measurement Command	MUX Identification	Channel Number	No. Data Values	SDI-12 Get Data Command
aM2!	MUX-0 Chan 0..15	Chan 0 ..15	returns 32 values 16 x Freq + 16 x Temp	aD0! aD1! aD2! aD3! aD4! aD5! aD6! aD7!

Table 5

Fig-39 Sensor Output Ports

Frequency -VW Sensor + VW Sensor Inputs  
Temperature -Therm / + Therm

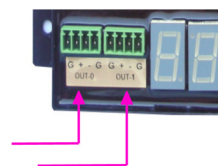

## Selecting a MUX-16/32 Channel

The VibWire-201-Pro can be used to manually select a channel on the MUX-16/32 expansion unit and take readings.

The feature enables the user to test sensors during an installation, or to use the MUX-16/32 expansion unit as a switch box. The channel selection works in 16 x 4 wire and 32 x 2 wire modes.

## MUX-16/32 Settings for operation with VibWire-201-Pro

The MUX-16/32 must be set to ID = 0

The setting of the MUX-16/32 ID number is easiest set using a USB-SDI12-Pro media converter and Q-LOG software. See Page H Appendix A for details.

Out-1 Port  
(VibWire-201-Pro)

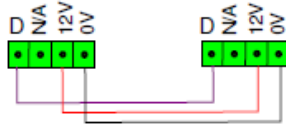

Control Port (MUX-16/32)

Wiring diagram for the MUX-16/32 control port to the VibWire-201-Pro

Fig 41

1. Connect the MUX-Ctrl port on the VibWire-201-Pro to the Control port on the MUX-16/32 expansion unit.

Figures 33 to 35, page 19 above show the wiring diagram for the MUX control ports.

## MUX-16/32 User Manual

Full details for the operation and configuration of the expansion unit can be found at:

<http://www.aquabat.net/downloads/mux32manualv1.pdf>

## Manually setting the MUX-16/32 Channel

Manually set the MUX-16/32 channel number. The channel range will depend on the scan mode assigned.

The MUX Chan number indicator will change as the 'Up' and 'Down' keys are pressed.

Fig 42

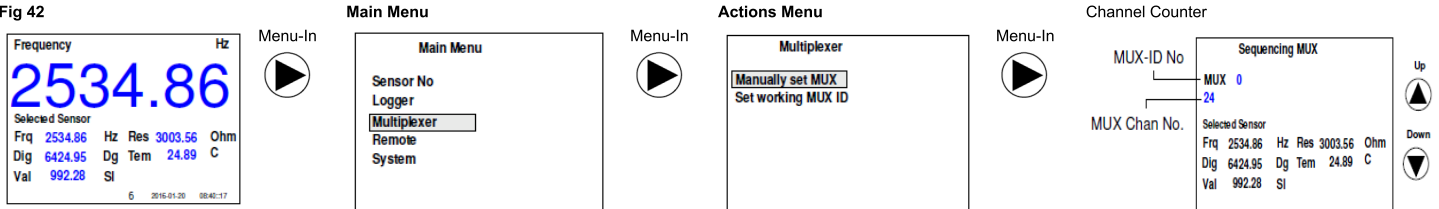

MUX 0 .. 15 4 Wire Mode - MUX-16/32 Channel counter changes between 0 ..15  
0 .. 31 2 Wire Mode - MUX-16/32 Channel counter changes between 0 ..31

## MUX-16/32 Expansion Unit Ports

Figure 40 below shows the output signal ports used with the MUX-16.32 expansion unit.

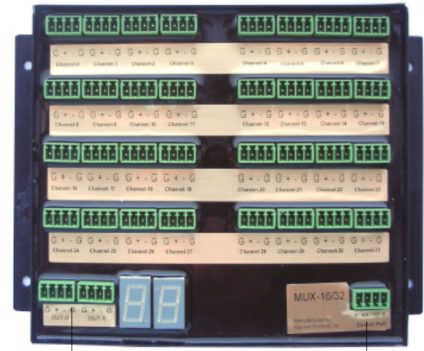

Output Signal Ports 0 & 1

Control Signal Port

Use the 'Up' and 'Down' buttons to change the MUX channel. The channel counter on the MUX-16/32 will update automatically.

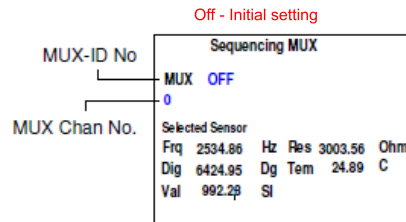

The image above shows the Initial Startup display should the MUX channel selection be activated without a MUX-16/32 expansion unit connected.

## Off - Initial Position 0 - 15 (4 Wire) and 0 - 31 (2 Wire)

### Channel Select Display



Fig 44

The menu system above shows the commands to follow to manually adjust the active MUX channel.

## Changing the MUX-13/32 Channel Number

Use the 'Up' and 'Down' keys to manually select the MUX-16/32 channel. As the keys are pressed the MUX-16/32 channel will increment.

The Channel counter on the menu system will increment/decrement at the same time as the MUX-16/32 unit.

## Temperature Compensated Calibration Factors - Results in Natural (SI) Units

The example below demonstrates how to use the calibration factors on a sensor data sheet, and local initial conditions to determine the factors to be used by the VibWire-201-Pro to give results in SI Units. The example sensor data sheet, see Appendix-B page 32 gives results in kPa. Use suitable scaling factors to convert the output into other SI Units. The formula section of Q-LOG can be used to convert pressure into other SI Units.

$$P(\text{kPa}) = G(R1-R0) + K(T1-T0) - (S1-S0) \quad \text{--- Sensor formula for conversion frequency (in Digits) to kPa}$$

where  $G$  = Linear gauge factor from the calibration data sheet.

$$= C(R1-R0)^2 + B(R1-R0) + A + K(T1-T0) - (S1-S0) \quad \text{--- Formula used by VW 201 pro software for configuration}$$

where  $A$ ,  $B$  and  $C$  are the calibration factors used in the VW201pro software.

For this example there is no  $C(R1-R0)^2$  and there is no barometer to correct for local barometric conditions.

Therefore the absolute water level measurements in kPa formula is now:

$$P(\text{kPa}) = B(R1-R0) + K(T1-T0) - \text{temperature corrected absolute level readings}$$

The initial condition measurements from the sensor are: **6064.0 Digits at 14 Deg C.**

Different initial conditions will change the final offset value only.

## Sensor Configuration Example - Piezometer

The following example shows how to configure the VibWire-201-Pro to use an Encardio-rite vibrating wire piezometer water level sensor. The piezometer is configured in a similar way as to a strain gauge but has the added complication of requiring barometric correction for true water level measurements.

This example will use only the linear formula to convert frequency to pressure into SI units of k Pa. (KiloPascal ) A copy of a sample calibration data sheet used in this example is shown in **Appendix-A**. The example demonstrates how to allow for initial conditions to improve the accuracy of the measurements.

For this example there is no  $C(R1-R0)^2$  and there is no barometer to correct for local barometric conditions.

Therefore the absolute water level measurements in kPa formula is now:

$$P(\text{kPa}) = B(R1-R0) + K(T1-T0) - \text{temperature corrected absolute level readings}$$

The initial condition measurements from the sensor are: **6064.0 Digits at 14 Deg C.**

Different initial conditions will change the final offset value only.

**G = 2.8388E-1 - See Cal Data sheet**

$$P(\text{kPa}) = G(R1-6064) + K(T1-14)$$

$$= 2.8388E-1*(R1-6064) - 0.087*(T1-14)$$

$$= (2.8388E-1*R1) - 1721.448 - (0.087*T1) + 1.218$$

$$= (2.8388E-1.R1) - (0.087.T1) - 1720.23$$

This formula gives the output from the sensor in kPa and allows for local temperature correction.

- where  $R0$  = Initial reading in Digits
- $T0$  = Initial sensor temperature Deg C
- $R1$  = Current Frequency reading in Digits
- $T1$  = Current temperature reading in Deg C
- $S1$  = Current barometer value - SI Unit KPa
- $S0$  = Initial Barometer reading - SI Unit KPa

Examining the formula now gives the parameters required for the VW201Cal software

**A = -1720.23      B = 2.8388E-1      D = -0.0870**

Process option - Digits

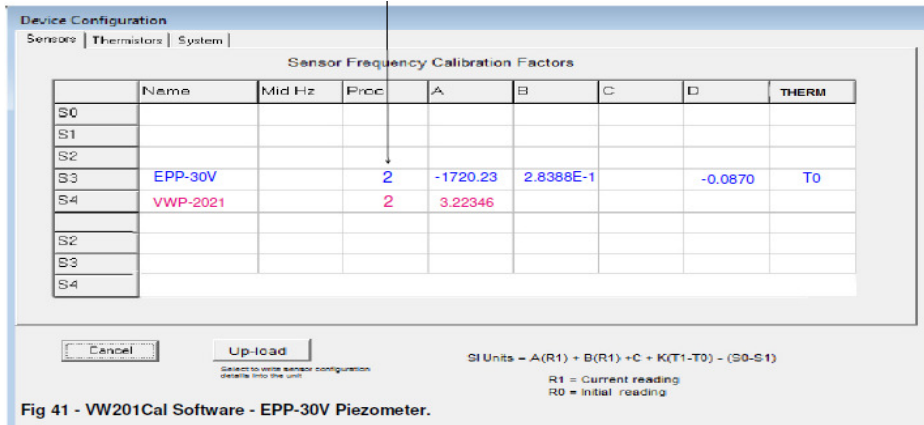

Fig 41 - VW201Cal Software - EPP-30V Piezometer.

Fig 45



## Simplified Calibration Factors

For some applications the temperature effects on the sensor are not significant and can be ignored. In this case the calibration factors can be simplified to using the gage factor. The gage factor is used to convert the sensor frequency in digits to SI units.

### Example use of Digits Calibration factor

If the initial conditions are: **6064.0 Digits**

then the simplified formula becomes much easier to use

$$\text{kPa} = G (R1 - 6064) \text{ gain from the calibration data sheet } G = 2.8388E-1 \text{ therefore } \text{kPa} = 2.8388E-1(R1 - 6064) \quad \text{where } R1 = \text{current reading} \\ = 2.8388E-1 - 1721.44$$

The output on the VibWire-201-Pro will now be the height of the water above the initial condition starting point in SI units kPa.

This gives the calibration factors for the VW201cal software as **A = -1721.44** and **B = 2.8388E-1**.

Figure 45 above, shows how the VW201cal software is configured for a Encardio-rite EPP-30V piezometer as sensor 3.

The output SI unit value will be in units kPa.

The output will be temperature compensated.

## Process Option setting

In order for the VW201-Pro to use the calibration factors in the software then the process option has to be set to 2.

### Thermistor Type

Enter the thermistor type into the cell labelled '**THERM**'. - Results in Deg C.

## Preset Sensor Configuration Settings

Once the calibration factors have been determined and set into the **VW201cal** software, then they will be automatically loaded into the VibWire-201-Pro. Storing the calibration factors done by simply connecting the device to the host PC using the micro-USB cable and pressing the '**Upload**' Button.

All defined sensor types will be loaded into the device and can be selected using the built in menu system. See Figure 45 above.

The device stores up to 200 individual sensor types.

## Q-Log - Quick User Guide

The VibWire-201-Pro is integrated into the Q-LOG Data Acquisition Software.

Q-LOG is the Keynes Controls software that is given away with the company's products and it can be used for Configuration, Data Recording, Data Display operations..Programming examples are supplied enabling 3rd party devices to be supported.

Q-LOG can be used for reading measurements across Wi-fi.

The VibWire-201-Pro can be used with both the SDI-12 and RS-485 ports in the Q-LOG software.

A copy of the Q-LOG software can be downloaded at:

[http://keynes-controls.com/Download/QLogSetup50\\_21may2020.zip](http://keynes-controls.com/Download/QLogSetup50_21may2020.zip)

A copy of the User manual can be downloaded at:

<http://www.keynes-controls.com//Q-log-guidev2.pdf>

### Factory Default Settings

The VibWire-201-Pro has the following default settings

ID = 0 Single Channel Operation for both SDI-12 and RS-485 networks

### Sample Rate Options

The sample rate options for single channel operation is:

1s , 10s, 30s,1 min, 10 min, 1 hour, 6 Hours.

**Maximum sample rate** = 1 Hz.

### Example

The example below assumes that the Q-LOG software has been installed and that a USB-12-Pro media converter is in use. 3rd party SDI-12 media converters will work with the Q-Log software but Keynes Controls do not support them.

USB-SDI12-Pro media converter using COMM Port 1 on the operating system.

The Q-LOG software can be used by third party media converters but they are not supported by Keynes Controls Ltd.

## Device Identification Strings

The VibWire-201 is identified in the Q-LOG software using the identification string highlighted below

Before data can be obtained from a device on the SDI-2 network it first has to be identified.

The procedure for identifying sensors and interfaces on a network is called '**Scanning for Devices**'. Figure 48 below shows how this is done

### Scanning for Devices

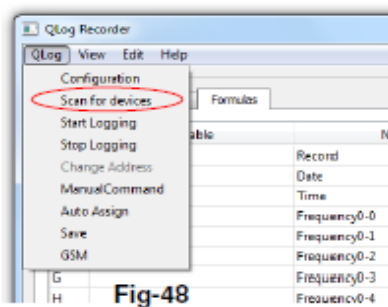

Fig-48

Select the '**Scan for devices**'.

The Status LED indicators on the USB-SDI12-Pro media converter illuminate during operations.

For a single device connected to a SDI-12 network then the device list will appear as shown below, see Figure 48.

Any additional sensors on the SDI-12 network require a separate and unique ID number, and will appear in the list below.

Product:	ID string:
VibWire-201-Pro VW sensor interface	13KEYNESCOVW101A011
VibWire-108 VW sensor interface	13KEYNESCOVW108A016
PIEZO-RM water level sensor	13KEYNESCOPIRESR001
Barom-SDI-12 barometer	13KEYNESCOBAROMR003
I-P-I	13KEYNESCOIPINCL005
AquaDAT sensor interface	13KEYNESCOAQUADAT008
Single channel strain gage	13KEYNESCOSTRAIN027
VibWire-201-Pro	13KEYNESVWRDOA001

Only after the device has been identified can the 'Configuration Window' be used to define the software operations.

The VibWire-201 supports both SDI-12 and RS-485 network operations. Set the '**Network Type**' to the chosen network in operation with the device.

## Q-LOG Configuration Window

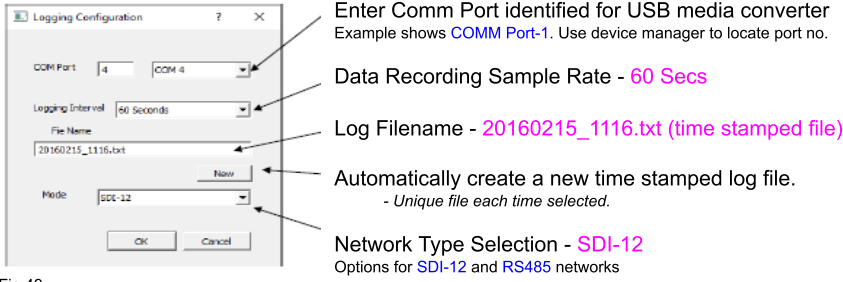

Fig 49

## PC Data Acquisition - Start Data Recording

Select the **'Start Logging'** menu option and measurements will be made and data stored to the results file..

If a USB-SDI12-Pro or USB-485-Pro media converter is being used then the device status LED indicators will flash after each measurement operation..

Q-LOG will run with 3rd party media converters..

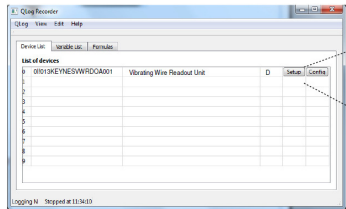

Fig-49

Q-LOG Devices List Window.



Press the 'Setup' button - from the list select **'Vibrating Wire Readout'**.

High speed single channel data acquisition readings for a single channel vibrating wire sensor can be made.

**Note.**

Fig-50

Start Data Logging menu option

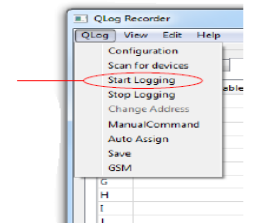

Start Data Acquisition

## SDI-12 / RS-485 Supported Commands

The following commands are supported by the VibWire-201-Pro and are used by data loggers and data acquisition systems. The commands have been included to allow the VibWire-201-Pro to operate easily with third party data loggers that support industry standard SDI-12 command set.

Prefix the commands in Table 3 below with the '%' for use in RS-485 data logger and acquisition systems.

Example, the command 'al!' becomes '%al!'. – access the device identifier string.

Table 6

Description	Master	VibWire-201 Response
Acknowledge active	a!	a\r\n
<b>Send ID:</b>  provided to complement SDI-12 protocol	a!  	a13KEYNESVWRDOA001\r\n  Part Description assigned by Keynes
<b>Address Query</b>  identifies instrument address and commonly used on single instrument operations only.	?!  Used to make command set SDI-12 compatible	a\r\n  Where a = ID number 0 - 9 (standard) / (a..z) Enhanced SDI-12 0 - 9 / a - z for RS485
<b>Change Address:</b>  used to change instrument address from a (initial) to b new ID for network operations	aAb!  a = initial address b = new address	b\r\n  a : b = number 0 - 9 or a - z
<b>Start Measurement</b>  instruct an instrument to make measurement	aM!  a = address of instrument example 0M! starts scan for ID 0	a0261\r\n ****  instrument with address a returns 1 x 4 wire reading in 1 second.
<b>Concurrent measurement:</b>  Used for starting a measurement for all instruments on a network at the same time.  This command frees RS-485 bus for other devices	aC!  start measurement instrument address 'a'	a0268\r\n  initial response only after receipt of instruct and no response when data ready to be sent.
<b>MUX-16/342 Expansion Unit</b>	32 x 2 Wire Measurements aM2! aD0! aD1! aD2! aD3! - 16 x Freq aM3! aD0! aD1! aD2! aD3! - 16 x Freq  16 x 4 Wire Measurements  aM2! aD0! aD1! aD2! aD3! aD4! aD5! aD6! aD7! D0-D4 = Frequency D4-D7 = Temperature	+xxxx.x+xxxx.x+xxxx.x+xxxx.x\r\n
<b>Thermistor 1 &amp; 2</b>	VibWire-201 supports 3 thermistor types	
<b>Thermistor Type 1</b> Temperature sensor settings  Parameters from the sensor calibration sheet  Steinhart-Hart Parameters Thermistor resistance/temp calculation	aXT1RE! aXT1T0! = 25 aXT1BET!  aXT1ST0! aXT1ST1! aXT1ST2! aXT1ST3!	Resistance at 25 Deg C T0 - generally 25 Deg C Beta Value  A in Steinhart-Hart B in Steinhart-Hart C in Steinhart-Hart D in Steinhart-Hart
<b>Thermistor Type 2</b> Temperature sensor settings  Parameters from the sensor calibration sheet  Steinhart-Hart Parameters Thermistor resistance/temp calculation  Page 36 shows sample calibration data sheet	aXT2RE! aXT2T0! = 25 aXT2BET!  aXT2ST0! aXT2ST1! aXT2ST2! aXT2ST3!	Resistance at 25 Deg C T0 - generally 25 Deg C Beta Value  A in Steinhart-Hart B in Steinhart-Hart C in Steinhart-Hart D in Steinhart-Hart
<b>VW Sensor Input Channel Settings</b>  Sets the process option for frequency calculations	aXCH0FN!  F = Frequency type N = VW Channel 0 .. 7	0 = output in Hz 1 = output in digits = F^2/1000 2 = use formula A + B*digits + C*digits^2 + D*temperature  digits = Frequency <sup>2</sup> in units of Hz <sup>2</sup>
<b>Thermistor Temperature Calculation</b>	aXT1TYn!  a = ID n = integer 0 .. 2	0 = resistance ratio - thermistor data sheet (R <sub>r</sub> /R <sub>25</sub> )  1 = Beta value calculation 1/T = 1/T <sub>0</sub> + log(r)/Beta where r = R <sub>r</sub> /R <sub>25</sub>  2 = Steinhart-Hart equation  1/T = A + B(Ln R <sub>r</sub> /R <sub>25</sub> ) + C(Ln R <sub>r</sub> /R <sub>25</sub> ) <sup>2</sup> + D(Ln R <sub>r</sub> /R <sub>25</sub> ) <sup>3</sup>

## Examples Of Using RS-485/SDI-12 Commands

The following examples show how to undertake the various tasks needed to set up and make readings across the RS-485 and SDI-12 networks. The command structure between the SDI-12 and RS485 models is essentially the same except all RS-485 commands use the '%' sign at the start of all instructions.

The SDI-12 network only supports up to 10 instruments with address range: 0 to 9 unless otherwise stated.

### Changing the ID Number (address)

The following example demonstrates how to change the instrument ID number from the default factory setting 0 to 5.

Use the command 'aAb!' where a = Start ID b = Final ID

SDI-12 master sends: '0A5!' Instrument responds 5\r\n Return New Line (5 representing new ID number)  
 '%0A5!' Instrument responds 5\r\n Return New Line (5 representing new ID number)

### ID Number Query

This command has been included to remain compatible with the SDI-12 and should be used for single instrument operations only. Useful command when identifying ID numbers for instruments to be deployed on a multi-instrument network.

The example below is to show the ID number of a single instrument

Use the command '?!'

master sends: '?!' Instrument responds 3\r\n Return New Line (3 is the ID number)

### Start a measurement for Instrument on a network

The following example shows how to start measurements on instruments with ID numbers 2

The instruments will start their measurement operations but will not send data across the network until instructed to do so.

Use the command 'aM!' where a = Instrument ID Number

Use the command '%aM!' for RS-485 network operation

The following example shows how to start measurements on instruments with ID numbers 2

The instruments will start their measurement operations but will not send data across the network until instructed to do so.

Use the command 'aM!' where a = Instrument ID Number

Use the command '%aM!' for RS-485 network operation

### Problems with measurement systems - Spikes in measurements

A common source of noise for vibrating wire measurement systems is earth - current loops.

Earth loop effects cause spikes in measurement values and can be intermittent. Earth loops are often caused by power supplies and multiple earth connections between different sections of a measurement system. Earth loop noise can cause random spikes.



### High Speed - Single Channel Data Recording

Single channel data recording and signals analysis is the most common operation undertaken with the VibWire-201-Pro. High speed data capture can be undertaken by setting the sample rate to 1 Hz.

1 Sec, 1 Minute, 10 Minutes, 1 Hour, 6 Hours

Use the 'Recording Interval' menu to set the desired sample rate.

Use the up and down keys to select the desired logging interval.

Down  Up  Measurement period = 1 Sec (Fastest logging rate)

Menu-Out  Select Menu-Out to store the menu option.

Recording Interval

Select Recording Interval

- 1 Second
- 10 Second
- 1 Minute
- 10 Minute
- 1 Hour
- 6 Hour

### Assigning the Data Recording Rate



Menu-In    Menu-In   

Fig 46

Use the 'Up' and 'Down' keys to select the sensor type.

The assigned sensor calibration factors will then be used by the VibWire-201-Pro to determine the SI units for any sensor that is attached.

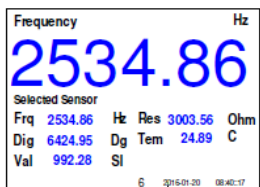
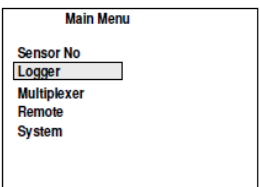
## Worked Example - Spot Welded VW Strain gauge

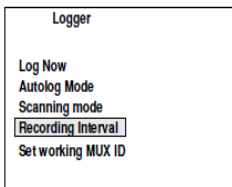
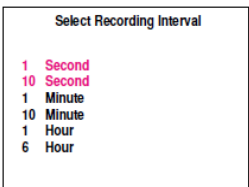
The following pages demonstrate how to use the VibWire-201-Pro to display values in engineering units. The examples below show the use of a strain gauge and piezometer and give engineering values in micro-strain.

### Vibrating Wire Strain Gauge Calibration Factors

Model	5200	5202	5204	5210	5214
Gage Factor	3.305	0.392	1.421	0.3569	0.3664
Start Frequency	450 Hz	1400 Hz	800 Hz	1400 Hz	1400 Hz
End Frequency	1200 Hz	3500 Hz	1600 Hz	3500 Hz	3400 Hz

$$\text{Digits} = \frac{\text{Frequency}^2}{1000} \quad \frac{(\text{Hz}^2)}{1000}$$

In order to use vibrating wire gauges and to display the results on engineering units, the calibration factors are based on using Digits (Hz<sup>2</sup>) as the measurement value.

Strain Gauge Type	Nominal Batch Factor (B)
5200	0.96
5202/5204/5210	0.92
5214	0.97

Table 5

Please Note.

The calculation allows for initial measurement conditions and gives the results in SI units - micro-Strain

A common procedure for calculating strain from a vibrating wire strain gauge uses the formulae:

$$\begin{aligned} \Delta_{\mu} &= (R1 - R0)G \times B \\ &= R1.G.B - R0.G.B \end{aligned} \quad \begin{aligned} \text{where } R0 &= \text{Initial condition reading (Digits)} \\ R1 &= \text{Current reading (Digits)} \\ G &= \text{Gauge Factor} \\ B &= \text{Batch factor} \end{aligned}$$

The equation can be re-written as:

$$\Delta_{\mu} = R1.A - D \quad \text{where } D = R0.G.B \quad \text{and } A = G.B$$

Now  $R0.G.B = \text{Constant Value} = A$  in the Windows calibration factors

Example. A model 5200 strain gauge is to be used with the VibWire-201-Pro to monitor strain on a bridge member. The gauge has been preset to operate at its midpoint and all subsequent measurements are to be taken from this initial condition.

Model 5200: **Start Freq = 450, End Frequency = 1200 Hz (Range = 1200 - 450) - Initial setting of the gauge = 450 + (Range / 2) = 825 Hz.**

Using Table 4, **Gauge factor = 3.305 and Batch factor = 0.96** Note. When the batch factor is missing from the calibration sheet use B = 1.

### VibWire-201 Results Display

The VibWire-201-Pro has to be set to show results in Digits, see Page 16 Figures 26 and 27..

$$\Delta_{\mu} = R1.A - D \quad \text{- Units micro-Strain}$$

$$R1.A - D \quad \text{where } A = 3.305 \times 0.96 \quad \text{and } D = \frac{(825 * 825) * 3.305 * 0.96}{1000}$$

$$\text{Therefore} \quad = 2159.487$$

$$\Delta_{\mu} = R1 * 3.1728 - 2159.487$$

If the strain gauge under load alters its operating frequency to 827.00 Hz then the display

The example below shows how to set the calibration factors for the Model 5200 strain gauge into the VW201cal setup software

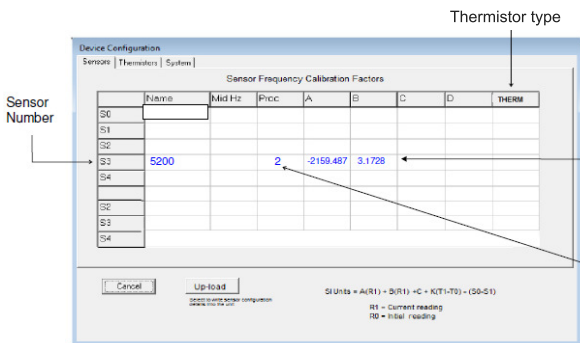
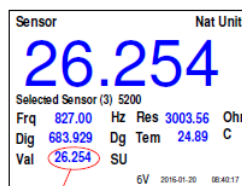

Fig-52 - Inserting Calibration Factor into VW201cal software



Example display for a **model 5200** vibrating wire strain gauge showing in output in micro-Strain.

The output allows for initial measurement conditions.

### Engineering Units

### SI Units - $\mu$ -Strain

Note 5200 - is just a sensor manufacturer part number.

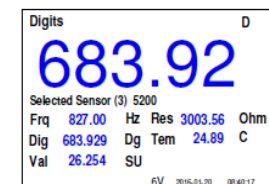
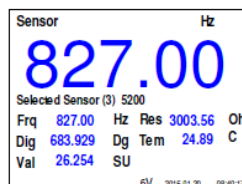



## Temperature Calibration Factors

Figure 53 below shows the thermistor setup Window of the VW201cal software.

The software currently supports 3 different thermistor configuration options. Most sensor manufactures use the same thermistor type for their temperature monitoring and so 3 defined thermistor type configuration options is sufficient for most applications. It is unlikely that any setting other than the default thermistor parameters are required for most sensor temperature readings regardless of the sensor manufacturer.

The VW201cal software has option **T0** pre-defined to the most common thermistor Stein-hart-Hart calibration factors used for the thermistor's built into vibrating wire sensors. These factors will work satisfactorily with most manufactured devices.

Keynes Controls recommends that option **T0** be selected when setting up a new sensor, and only changed if proved inaccurate for a defined sensor.

To write new calibration factors into a VibWire-201-Pro unit make sure that the device is connected to a USB port on the host PC running the VW201cal software. See Figure 64 on page 23. Press the 'Connect' button to start communications with the device.

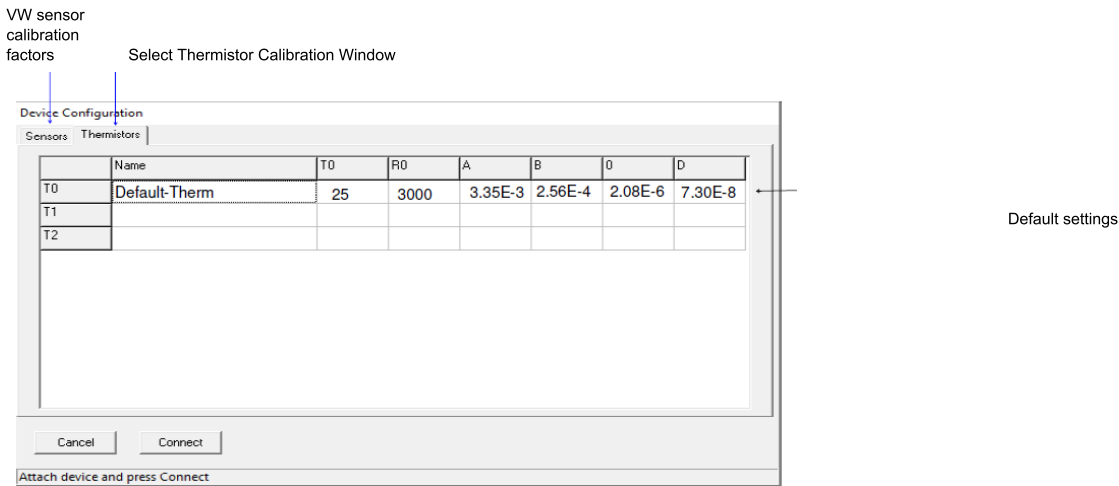

Fig 53

## Adding a new thermistor type

This is a simple operation using the VW201Cal Windows software package.

### Calibration parameters and what they mean

Each thermistor obtained from a reputable supplier will have the following calibration factors defined on it's calibration data sheet. R0 = Resistance at temperature T0. For vibrating wire sensors these are most commonly set at R0 = 3 K Ohm, and T0 = 25 Deg C. The resistance of the thermistor is 3 K ohm at a temperature of 25 Deg C.

Each sensor has 4 calibration factors labelled A,B,C and D on the calibration sheet. These factors are used by a polynomial equation to convert resistance to Temperature.

### Sample Calibration Factors

The following factors have been created for example purposes only.

A thermistor with T0 = 25 Deg C and R0 = 3300 Ohms. Stein-hart Hart calibration factors are:  
 A = 4.6541E-3, B = 2.675E-4, 3.05E-6, 5.07E-8.

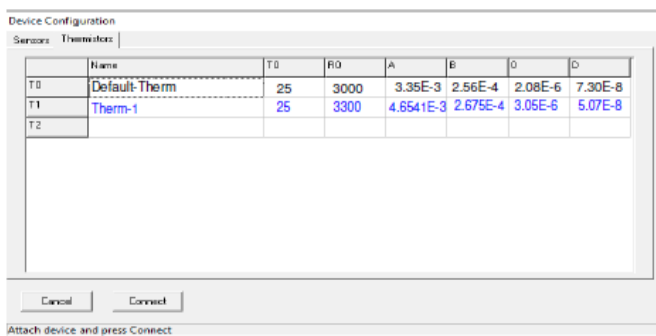

Fig 54 VW201cal - Thermistor Calibration factors

1. Select the 'Thermistor' Tab.
2. Assign name - It is a good idea to use a unique name for each new sensor type.
3. Fill in the calibration constants into the table.

Cell 'A' = 4.6541E-3 Cell 'B' = 2.675E-4

repeat until all the cells are filled.

Once the cells are filled simply press the '**Connect**' button to write the parameters to the VibWire-201-Pro.

## Temperature Measurements

The VibWire-201-Pro is capable of accurate temperature measurements suitable for many geotechnical and laboratory measurements. The thermistor temperature sensor built into most vibrating wire sensors connects directly into the device.

The VibWire-201-Pro can make temperature measurements simultaneously to the frequency measurements when in 16 x 4 Wire mode.

The VibWire-201-Pro can also act as a stand-alone temperature recorder in 32 x 2 Wire mode using the MUX-16/32 expansion unit.

## Factory Set Steinhart Hart Calibration Factors

The VibWire-201-Pro is supplied pre-set to use

Steinhart-Hart 0th order (A)	3.35E-3
Steinhart-Hart 1st order (B)	2.56E-4
Steinhart-Hart 2nd order (C)	2.08E-6
Steinhart-Hart 3rd order (D)	7.30E-8

Beta 5234

The VibWire-201-Pro default thermistor settings will give accurate results for most of the different manufactures vibrating wire sensors.

Full adjustment to the calibration factors can be carried out using the VW201cal.exe Windows software.

## Testing the temperature measurements

Fit a 3.3 K Ohm to the thermistor input port.

Set the thermistor input uses the default calibration parameters as shown above.

### 22 Deg C fixed point - 3.3 K Ohm temperature test resistor

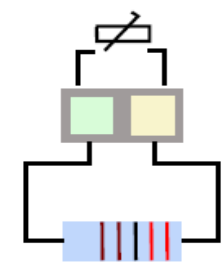

3.3 K Ohm metal film resistor  
+/- 1% Tolerance

Thermistor  
Input  
Signal  
Port

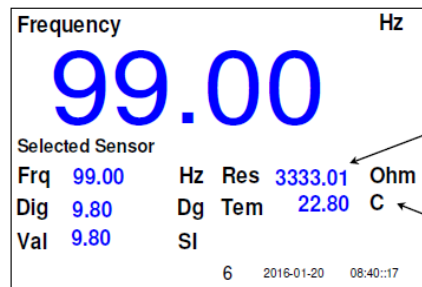

Fig-55

3.3 K Ohm Sense Resistor

Thermistor  
Resistance  
Value

VW sensor  
Temperature  
Deg C

With no frequency input to the VibWire-201-Pro display screen will default to 99.00

The device measures and displays the temperature sensor resistance in Ohms, see Fig 66 opposite.

The higher value sense resistor, then the lower the temperature that is being simulated.

### 52 Deg C fixed point - 1 K Ohm temperature test resistor

Thermistor Input Signal Port

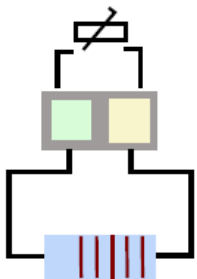

1.0 K Ohm metal film resistor  
+/- 1% Tolerance

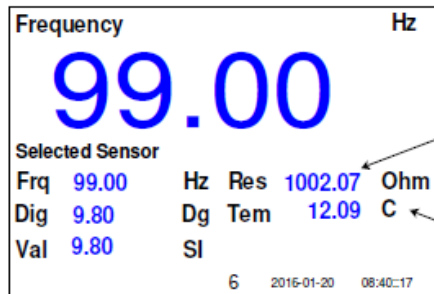

Fig 56

1 K Ohm Sense Resistor

Thermistor Resistance Value

VW sensor Temperature Deg C

Metal film resistors have excellent stability under load and severe environmental conditions, and can be sourced from many different suppliers.

## Sensor Problems and Diagnostics

The spectral display feature of the VibWire-201-Pro offers the user an excellent tool for testing and diagnosing sensor problems. The ability to observe a sensor signal in the frequency domain enables the User to observe that a sensor is installed and operating correctly. Should a sensor installation be badly installed then the spectra will show unusual spectral components.

Due to how the vibrating wire sensors operate, each sensor in a system can be examined from a central point, such as where the sensor cabling goes into a logger system, since the cable length from the sensor to the device has little to no effect on the measurements to be made. All sensors can be examined before installation into a permanent logging system.

### Spectra (Hz)

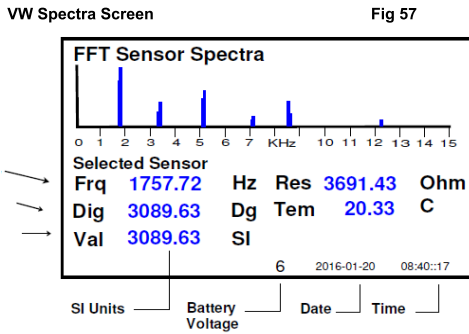

Frequency (Hz)  
 Digits - Hz<sup>2</sup>/1000  
 Engineering Units  
 No SI Unit calibration factors in use.

Figure 57 opposite shows the spectral display screen used to display the frequency components of a vibrating wire sensor signal on the VibWire-201-Pro. See page 30 for the menu selection operations required to access this display.

The images below demonstrate the use of the Spectral FFT display to show the operating features for an arc welded vibrating wire strain gauge.

## Sensor Operating Characteristics

The examples below are taken from a UK manufactured spot welded vibrating wire strain gauge.

Due to the physical size of the strain gauges and regardless of the manufacture, nearly all of the spot welded vibrating wire strain gauges have similar operating characteristics. The strain gauges typically have high operating frequencies when deployed correctly.

The Operating frequency of the sample gauge is between 1500 to 3 K Hz. The sensors give out their optimum signal strength only when operating within their defined range, and installed correctly onto a suitable structure. A arc welded strain gauge has to be pretensioned before use.

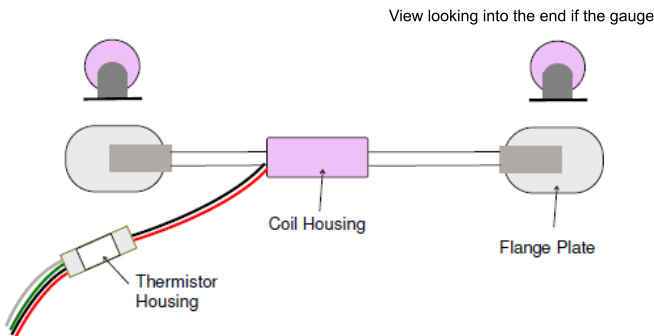
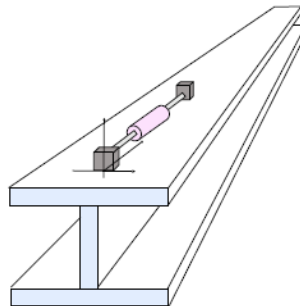
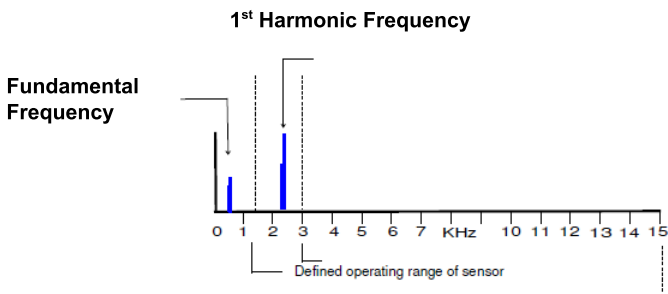

Fig-58 Typical Spot Welded Strain Gauge



The figure opposite shows a typical application for the use of the spot welded vibrating wire strain gauge.



2564.81 = Fundamental Frequency in Hz  
 6578.66 = Fundamental Frequency in Digits

Maximum Operating Frequency

Fig-59 Freestanding Strain Gauge Spectra

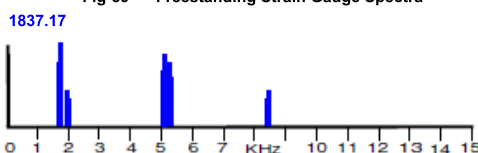

### Free Standing Strain Gauge

Fig 58 opposite shows a typical spectra for a free standing gauge.

The fundamental frequency as calculated by the VibWire-201-Pro is outside the defined operating range for this type of sensor. The spectral display clearly shows that a fault condition has occurred.

Figure 60 shows additional details that can be seen on a sensor spectra. The additional harmonics can be caused with flaws in the sensor installation.

Fundamental Frequency    1<sup>st</sup> Harmonic Frequency

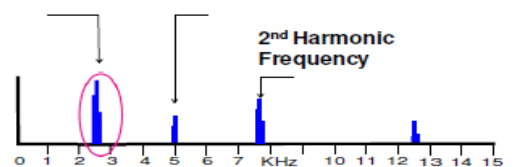
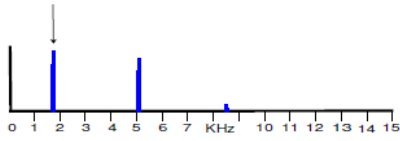

Fig 60

## VW strain gauge - Failed or loose weld

**Fundamental Frequency** If one of the flange plates fails and comes away from the structure then spectral results similar to that below will occur.



1702.61 = Fundamental Frequency in Hz  
2898.88 = Fundamental Frequency in Digits

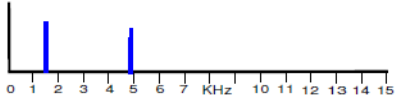

2002.88 = Fundamental Frequency in Hz  
4011.52 = Fundamental Frequency in Digits

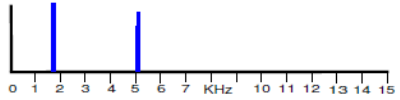

1837.17 = Fundamental Frequency in Hz  
3375.19 = Fundamental Frequency in Digits

Permanently fixed to structure

Welded flange plate to structure still attached,

This arm of the gauge has come away totally, or has a cracked weld onto the flange plate.

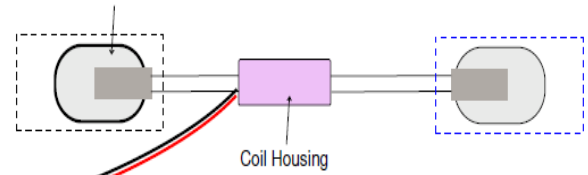

Fig 61

The fundamental frequency can vary considerably. The 3rd harmonic levels can become higher magnitude than fundamental and so the recorded results will be erratic.

The VibWire-201-Pro results will oscillate to values between the fundamental and harmonic signal components

## **APPENDIX-A**

### **Menu System Summary**

# Configuration Menu Options

The following page shows a summary of the menu options used by the

VibWire-201-Pro.

**Spectra** Results Menu Selection Options Fig 62

The 'Spectra' section shows four menu options for displaying results: 'Hz', 'Hz<sup>2</sup>', 'SI Units', and 'Hz' with a graph. Each option shows a main display with a large frequency value (2534.86) and a smaller value (992.28), and a secondary display with a graph or additional data points.

**Remote Readout** Fig 63

The 'Remote Readout' section shows four menu options: 'Main Menu' (Sensor No, Logger, Multiplexer, Remote, System), 'Remote' (Address, Serial Comms), 'Address' (Serial Comms), and 'Select Backlight' (SDI12, RS485 1200).

**Backlight**

The 'Backlight' section shows four menu options: 'Main Menu' (Sensor No, Logger, Multiplexer, Remote, System), 'System' (Set Time and Date, Speaker ON/OFF, Backlight, Info, Reset Defaults), 'Backlight' (Off, Low, High), and 'Select Backlight' (SDI12, RS485 1200).

To optimise the battery life set the backlight intensity to make the results clearly visible under the conditions of operation. The battery life will be optimised with the back light switched off.

Fig 64

**Setting Network ID Number** Set backlight intensity

The 'Setting Network ID Number' section shows four menu options: 'Main Menu' (Sensor No, Logger, Multiplexer, Remote, System), 'Remote' (Address, Serial Comms), 'Selected Serial Comms' (0-7), and 'Set backlight intensity' (0-7).

Sets the ID for the RS-485 and SDI-12 ports.

Fig 65

**SDI-12 Port Operation**

The 'SDI-12 Port Operation' section shows four menu options: 'Main Menu' (Sensor No, Logger, Multiplexer, Remote, System), 'Remote' (Address, Serial Comms), 'Set of Backlight' (SDI12, RS485 1200), and 'Selected Backlight' (SDI12, RS485 1200).

Sets the VibWire-201-Pro to transmit data through the SDI-12 Port

Fig 66

**RS485 Port Operation**

The 'RS485 Port Operation' section shows four menu options: 'Main Menu' (Sensor No, Logger, Multiplexer, Remote, System), 'Remote' (Address, Serial Comms), 'Set of Backlight' (SDI12, RS485 1200), and 'Selected Backlight' (SDI12, RS485 1200).

Sets the VibWire-201-Pro to transmit data through the RS-485 Port.

Fig 67

The MUX-1632 expansion units fitted for 16 x 4 wire or 32 x 2 wire operations.

## Scanning Modes Menu

16 x 4 or 32 x 2 scanning modes require the MUX-16/32 unit to be attached. Remember to set MUX-16/32 scan mode for the expansion unit selecting expanded data recording modes.

**Recording Interval**

The 'Recording Interval' section shows four menu options: 'Main Menu' (Sensor No, Logger, Multiplexer, Remote, System), 'System Setup' (Log Now, Autolog Mode, Scanning mode, Recording Interval, Set working MUX ID), and 'Selected Scanning mode' (Single Chan, 16x4 (VW and Temp), 32x2 (VW only), 32x2 (Temp only)).

Fig 68

**Time & Date Settings**

The 'Time & Date Settings' section shows four menu options: 'Main Menu' (Sensor No, Logger, Multiplexer, Remote, System), 'Logger' (Log Now, Autolog Mode, Scanning mode, Recording Interval, Set working MUX ID), 'Select Recording Interval' (1 Second, 10 Second, 1 Minute, 10 Minute, 1 Hour, 6 Hour), and 'Set Time and Date' (Date: 2016-01-06, Time: 08:25:30).

1 and 10 second logging is only available on single channel measurements.

1 min, 10 min, 1 Hour, 6 Hour logging MUX-16/32 expansion unit.

Fig 69

**Chanel Expansion Options**

The 'Time & Date Settings' section shows four menu options: 'Main Menu' (Sensor No, Logger, Multiplexer, Remote, System), 'System' (Set Time and Date, Speaker ON/OFF, Backlight, Info, Reset Defaults), 'Set Time and Date' (Date: 2016-01-06, Time: 08:25:30), and 'Selected Scanning mode' (Single Chan, 16x4 (VW and Temp), 32x2 (VW only), 32x2 (Temp only)).

Fig 70

**Chanel Expansion Options**

The 'Chanel Expansion Options' section shows four menu options: 'Main Menu' (Sensor No, Logger, Multiplexer, Remote, System), 'System Setup' (Log Now, Autolog Mode, Scanning mode, Recording Interval, Set working MUX ID), and 'Selected Scanning mode' (Single Chan, 16x4 (VW and Temp), 32x2 (VW only), 32x2 (Temp only)).

Fig 71

The menu system above shows how to set the VibWire-201 for operation with the MUX-16/32 expansion unit.



## Auto-Logging Menu

Start the data recording operations to the SD Flash memory card. Single channel mode - is only for the sensor attached directly to the device. 16 x 4 or 32 x 2 scanning modes require the MUX-16/32 unit to be attached. Remember to set MUX-16/32 scan mode for the expansion unit before starting the data recording operations.

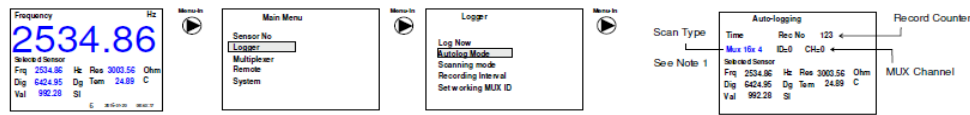

## Manually Set MUX-16/32 Channel

Manually set the MUX-16/32 channel number. The channel range will depend on the scan mode assigned. The MUX Chan number indicator will change as the 'Up' and 'Down' keys are pressed.

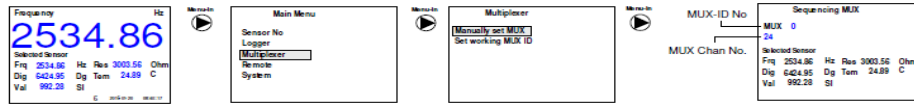

**Up** Use the 'Up' and 'Down' buttons to change the MUX channel. The channel counter on the MUX-16/32 will update automatically.

**Down** **MUX 0 .. 15 4 Wire Mode - MUX-16/32 Channel counter changes between 0 ..15**  
**0 .. 31 2 Wire Mode - MUX-16/32 Channel counter changes between 0 ..31**

## System Information Mode



Fig 74

## Sensor Setup

### Select a sensor type for measurement operations

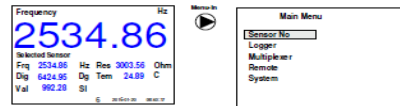

### Default display with no sensor names defined



Fig 75

**Up** Use the 'Up' and 'Down' keys to select the sensor type.

**Down** The assigned sensor calibration factors will then be used by the VibWire-201-Pro to determine the SI units for any sensor that is attached.

## Inspection

It is vital to check all the equipment in the shipment as soon as possible after taking delivery and well before any field use is to be carried out.

Check that the case has not been physically damaged in shipment.

Install a new set of batteries.

In the case of units shipped with the protective environmental cases then new battery sets should be included with the instrument.

**APPENDIX-B**  
**Sample Calibration Data Sheets**

Sensors

Piezometer  
Spot Welded Strain Gauge

# Appendix - C

## Sample Vibrating wire Displacement Sensor Calibration Data Sheet



# Encardio-rite Electronics Pvt. Ltd.

A-7 Industrial Estate, Talkatora Road, Lucknow, UP-226011 India

E-mail: geotech@encardio.com, lko@encardio.com; Website: www.encardio.com

Tel. +91 (522) 2661039/40/41/42 Fax +91 (522) 2662403



## TEST CERTIFICATE

DWT Traceable to standard no. : J082301 T8F 281 TC

Customer	:		Date	:	02.02.2012
P.O. No.	:		Temperature	:	19°C
Instrument	:	V W Piezometer	Atm. Pressure	:	100 kPa
Serial number	:	xxxxx			
Capacity	:	350 kPa			

Input pressure (kPa)	Up1 (Digit)	Observed value Down (Digit)	Up2 (Digit)	Average (Digit)	End Point Fit (kPa)	Poly Fit (kPa)
0.0	6555.9	6556.9	6556.9	6556.4	0.0	0.3
70.0	6312.4	6312.6	6312.4	6312.4	69.3	69.5
140.0	6064.0	6064.3	6063.1	6063.5	139.9	140.1
210.0	5817.1	5818.4	5816.2	5816.7	210.0	210.1
280.0	5569.8	5570.7	5568.0	5568.9	280.3	280.3
350.0	5323.3	5323.3	5323.7	5323.5	350.0	349.8

Digit :  $f^2/1000$   
 Linear gage factor (G) : 2.8388E-01 kPa/digit  
 (Use gage factor with minus sign with our read out unit Model : EDI-51V)  
 Thermal factor(K) : -0.087 kPa/°C  
 Polynomial constants :  
**A= -2.2253E-07**      **B= -2.8085E-01**      **C= 1.8512E+03**

Pressure "P" is calculated with the following equation:

Linear :  $P(\text{kPa}) = G(R0 - R1) + K(T1 - T0) - (S1 - S0)$

Polynomial :  $P(\text{kPa}) = A(R1)^2 + B(R1) + C + K(T1 - T0) - (S1 - S0)$

R1 = current reading & R0 is initial reading in digit.

S1 and T1 = current atmospheric pressure(kPa) and temperature (°C)

Readings at the time of shipment

f	:	Hz
f <sup>2</sup>	:	Digit
Temperature	:	°C
Thermistor	:	Ohm
Atm. pressure	:	kPa
Coil resistance	:	Ohm

The terms K(T1-T0) are the temperature compensation terms for this sensor.

Temperature compensated readings only work if the thermistor operation is defined.

(Zero conditions in the field must be established by recording the reading R0 (digit) along with temperature T0 (°C) and atmospheric pressure S0 (kPa) at the time of installation. If polynomial constants are used, determine value of 'C' as per § 6.2 of user's manual.)

The example above is for a VW Piezometer and so the engineering units calculations vary between the different sensor types.

For a Piezometer the local barometric levels are taken into consideration.

The engineering units for this example is K Pa

The term (S1-S0) is a constant offset that allows for local atmospheric conditions and be taken from a barometer module such as models **Barom-SDI12** or **Barom-485**.

The VW sensor units have to be set to 'Digits' that is Hz<sup>2</sup>/1000.

**Appendix A - Calibration Sheet Example**

**SAMPLE**

# KEYNES CONTROLS LTD

Unit B1, Lambs Farm Business Estate  
Basingstoke Road, Swallowfield, Berks, RG7 1PQ

t: +44(0)118 327 6067  
e: sales@keynes-controls.com

Keynes Controls Ltd, Registered in England, Number 3199347

## VIBRATING WIRE INSTRUMENT CALIBRATION CERTIFICATE

Sensor Type	KDE-V150	Serial Number	100002
Instrument Range	0.00 to 150.00 mm	Calibration Date	1/6/2017
Linear Gauge Factor	0.0652	Calibration Temperature	21 Deg C
Polynomial Gauge Factor A	-1.26E+02	Barometric Pressure	1011 mb
Polynomial Gauge Factor B	6.52E-02	Calibration Eng:	Dr Paul Bayton
Polynomial Gauge Factor C	3.42E-02	Calibration Equipment	VW201-Pro Digital micrometer
Temperature Correction Coeff.	-1.40E-02		

### Measurement Points

x (mm)	F (Hz)	d (Hz <sup>2</sup> )
0	1385.1	1918.5
75	1743.4	3039.4
150	2036.6	4147.7

### Calibration Factors

All of the KDE-VXX range of displacement sensors use the following calibration equations to convert frequency into SI units:

$$X = A + Bd + Cd^2 - Dt \quad \text{where } d = F^2 / 1000 \text{ (Digits) in } m \text{ Hz}^2$$

and D = Temperature Correction Coefficient  
t = temperature in Deg C

The instrument detailed above has, as acceptable, been tested and calibrated in accordance with procedures, which are part of our ISO 9001:2015 Quality Management System, and unless otherwise indicated, performs within +/- 0.20 % Full Scale (Polynomial) as specified. The sensor conforms in all respects to the relevant specifications and drawings.

Certified: ..... Engineer



## Keynes Controls - KDE-V150 - Sample Sensor Configuration

The image below shows the VibWire-201-pro Setup software configured to use the sample calibration factors for a Keynes Controls KDE-V150 vibrating wire displacement sensor shown on page 40..

Once the additional sensor calibration factors are loaded into the software they can be

Process Option

Thermistor Calibration Factors

0 = Frequency, 1 = Digits, 2 = SI Units

Device Configuration  
Sensors | Thermistors | System

Sensor Frequency Calibration Factors

	Name	Mid Hz	Proc	A	B	C	D	THERM ←
S0	KDE-V150		2	-1.26E+02	6.52E-02	3.42E-02	-1.40E-02	T0
S1								
S2								
S3								
S4								
S2								
S3								
S4								

Cancel Up-load

SI Units = A(R1) + B(R1) + C + K(T1-T0) - (S0-S1)  
R1 = Current reading  
R0 = Initial reading

Write configuration details into the device.

$$SI \text{ Unit} = A + B(R1) + C(R1)^2 + D(T)$$

where R1 = Current Reading  
T = Temp Deg C  
D = Thermal Factor

## Limited Warranty

The manufacturer, Keynes Controls Limited, warrants the VibWire-201-Pro manufactured by it, under normal use and service, to be free from defects in material and workmanship under the following terms and conditions:-

Sufficient information has been provided to Keynes Controls by the purchaser as regards the operating environment to allow Keynes Controls to check compatibility of the VibWire-201-Pro and other component parts.

In the absence of any site data being provided by the purchaser standard construction materials will be supplied. All costs for subsequent modifications will be borne by the purchaser.

The VibWire-201-Pro instrumentation shall be installed or used in accordance with the manufacturer's recommendations.

The equipment is warranted for 1 year from the date of shipment from the manufacturer to the purchaser.

The warranty is limited to replacement of parts or parts which are determined to be defective upon inspection at the factory. Shipment of defective part or parts to the factory shall be at the expense of the Purchaser. Return shipment of repaired/replaced part or parts covered by this warranty shall be at the expense of the Manufacturer.

Unauthorised alteration and/or repair by anyone which causes failure of the unit or associated components will void this LIMITED WARRANTY in its entirety.

The Purchaser warrants through the purchase of the VibWire-201-Pro equipment that he is familiar with the equipment and its proper use. In no event shall the manufacturer be liable for any injury, loss or damage, direct or consequential, special, incidental, indirect or punitive, arising out of the use of or inability to use the equipment sold to the Purchaser by the Manufacturer. The Purchaser assumes all risks and liability whatsoever in connection with the VibWire-201-Pro instrumentation from the time of delivery to Purchaser.

## RETURN OF GOODS

### 1 Returns procedure

If goods are to be returned for either service/repair or warranty, the customer should contact Keynes Controls Ltd for a Returns Authorisation Number, request a Returned Equipment Report Form and, where applicable

The Goods Returns Numbers must be clearly marked on the outside of the shipment.

Obtain from Keynes Controls and Complete the Returned Equipment Report Form , including as much detail as possible, and enclose it with the returned goods.

A copy of Good Returns Form should be faxed / emailed to the Keynes Controls Ltd offices, in advance of shipping the goods.

### Chargeable Service or Repairs

#### Inspection & Estimate

It is the policy of Keynes Controls Ltd that an estimate is provided to the customer prior to any repair being carried out. A set charge for inspecting the equipment and providing an estimate is sometimes chargeable.

#### Packaging and Carriage

All used goods shipped to the factory must be sealed inside a clean plastic bag and packed in a suitable carton. If the original packaging is not available, Keynes Controls Ltd should be contacted for advice. Keynes Controls Ltd will not be responsible for damage resulting from inadequate returns packaging under any circumstances.

#### Transport & Storage

All goods should be adequately packaged to prevent damage in transit or intermediate storage.

#### Warranty Claim

(See Limited Warranty Conditions - Page 36)

This covers defects which arise as a result of a failure in design or manufacturing. It is a condition of the warranty that the VibWire-201-Pro must be operated only in accordance with the manufacturer's instructions and has not been subject to misuse.

## CONFORMITY

Keynes Controls Ltd  
Pakenham House  
Riseley Business Park  
Riseley  
RG7 1NW  
United Kingdom

Tel: +44 (0)118 327 6067

E-mail: [sales@keynes-controls.com](mailto:sales@keynes-controls.com) , Web: [www.keynes-controls.com](http://www.keynes-controls.com)

### Declaration of Conformity

We Keynes Controls Ltd at above address declare under our sole responsibility that the product detailed below to which this declaration relates complies with protection requirements of the following harmonized EU Directives,

Low Voltage Directive 73/23/EEC (as amended by 93/68/EEC)  
The Electromagnetic Compatibility Directive 2004/108/EC  
The Construction Products Directive 89/106/EEC

Equipment description Vibrating Wire Sensor Interface  
Make/Brand: VibWire



**Model Number:** VibWire-201-Pro

This equipment has been designed and manufactured with reference to EN 61326-1 and EN 61010. All mechanical drawings used in the production of this equipment are based upon BS 8888 and all electrical/electronic drawings are based upon BS 3939.

A technical file for this equipment is retained at the above address.

Ian Thomas

Director

**Remote Communication Options.**

The VibWire-201-Pro can be used with a range of communication devices to enable the device to transmit data across wireless networks for cable free operations. The devices include WiFi modem for connection onto popular industry standard WiFi networks, and wireless network modems data recording applications where cabling solutions cannot be practically installed.

**WiFi Modem**



With this WiFi serial adapter you can connect the VibWire-201-Pro to your computer over a standard WiFi network.

Data can be transferred over TCP/IP, UDP or HTTP with the advantage of using 802.11 b/g/n infrastructure or Ad Hoc mode (Simple AP / Station Mode) networking which allows you to use existing wireless WiFi network connectivity, and it allow you to connect a standard RS485 to any secure or open wireless network or access point.

The WiFi modem enables data from remote instruments to be recorded automatically into the Q-LOG Software.

Remote Out-station

**Distributed WiFi Data Acquisition System**

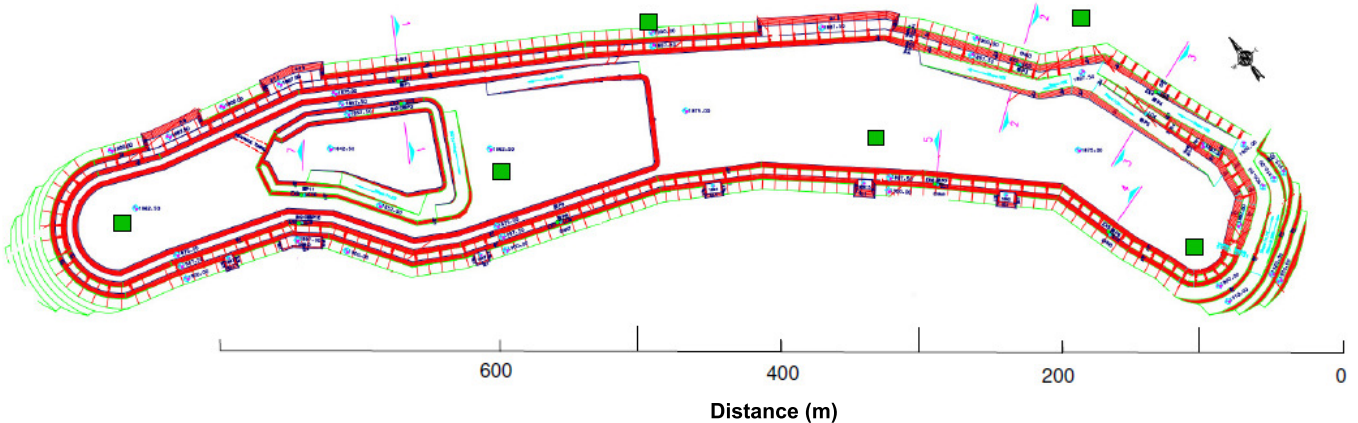

**Cable Free RS-485 Network**



The VibWire-201 radio connects to the RS-485 to Wi-Fi modem using RS-485 port located on the front of the device..It is used for applications between host data logging computers and remote devices. It is also useful for those applications where cable installation is difficult or impractical.

Different antenna options enabling long and short range operations.

RS485 to WiFi Converter

# Index

<b>KEYNES CONTROLS Ltd</b>	<b>1</b>
Model VibWire-201-Pro	1
Features	2
Benefits	2
<b>Applications Software</b>	<b>3</b>
<b>Downloading and Installing device setup software</b>	<b>3</b>
IMPORTANT NOTE	3
<b>Important Notes - Sample Rates</b>	<b>4</b>
<b>Factory Default Setting Reset</b>	<b>4</b>
<b>Data Storage</b>	<b>4</b>
Micro-USB Port (Type B)	4
SDHC Flash Memory	4
<b>Data Storage to the SD Memory Card</b>	<b>4</b>
Memory Card Type	4
SD Card - Error Message	4
Removing the Memory Card	4
<b>Features</b>	<b>5</b>
<b>Quick User Guide</b>	<b>6</b>
Default Thermistor Part Numbers	6
Automatic Time-out	6
Power On The VibWire-201-Pro.	6
Connecting a Sensor to the Device	6
<b>Real-time Results</b>	<b>6</b>
<b>Storing the menu option</b>	<b>6</b>
<b>Adjusting the display</b>	<b>7</b>
<b>VW Sensor Installation</b>	<b>7</b>
<b>Fitting Batteries</b>	<b>8</b>
Battery Life	8
Low Battery Level Effects	8
<b>External Power Supply</b>	<b>8</b>
<b>Setting the Real-time Clock</b>	<b>9</b>
Adjusting the Time	9
Saving New Clock Parameters	9
Automatically setting the Real-time Clock	10
<b>Real-time Results Display Parameters</b>	<b>10</b>
Pre-defined Thermistor Calibration Parameters	10
<b>Results Display</b>	<b>11</b>
<b>Selecting Remote Network Connections</b>	<b>12</b>
Device Port Selection	12
SDI-12 Port Selection Menu	12
RS485 Port Selection Menu	12
<b>Technical Specification</b>	<b>13</b>
Associated Part Numbers	13
Device Configuration Software	13
SDI-12 Network Connection	14
USB Media Converters	14
RS-485 Network Connection	14
Temperature Measurements	15
Common VW Sensor Thermistor Part Numbers	15
Sources of Error	15
Calibration Factor Error	15
User Defined Steinhart-Hart Calibration Factors	15
Sensor Information	15
<b>Pre-set Sensor Configurations</b>	<b>16</b>
Device returns Data in SI Units	16
<b>Frequently Asked Questions</b>	<b>17</b>
Network ID Number	17
How fast can the VibWire-201-Pro make a measurement?	17
Where Can I download a copy of Q-LOG software ?.	17
How to make measurements on my PC without any programming experience.	17
<b>Channel Expansion Options</b>	<b>18</b>
MUX-16/32 Control Port	18
MUX-16/32 Signal Output Ports	18
<b>MUX-16/32 Expansion Operations</b>	<b>18</b>
<b>VibWire-201 to MUX-16/32 Sensor Connection</b>	<b>19</b>
<b>Channel Expansion Options</b>	<b>19</b>
<b>Number of Channels</b>	<b>20</b>
MUX-16/32 Expansion Unit	20
Data Recording File Format and File System Type	20
Data Recording Menu Options	20
<b>Commands for scanning MUX-16/32 in 32 x 2 wire mode</b>	<b>21</b>
Switching between 2 & 4 Wire Mode Operation under SDI-12 Command	21
<b>Commands for scanning MUX-16/32 in 16 x 4 wire mode</b>	<b>21</b>
Selecting a MUX-16/32 Channel	22

MUX-16/32 Settings for operation with VibWire-201-Pro	22
Changing the MUX-13/32 Channel Number	22
Temperature Compensated Calibration Factors - Results in Natural (SI) Units	23
<b>Sensor Configuration Example - Piezometer</b>	<b>23</b>
<b>Simplified Calibration Factors</b>	<b>24</b>
Process Option setting	24
Preset Sensor Configuration Settings	24
<b>Q-Log - Quick User Guide</b>	<b>25</b>
Device Identification Strings	25
Scanning for Devices	25
Q-LOG Configuration Window	26
PC Data Acquisition - Start Data Recording	26
<b>Examples Of Using RS-485/SDI-12 Commands</b>	<b>28</b>
Changing the ID Number (address)	28
ID Number Query	28
Start a measurement for Instrument on a network	28
Problems with measurement systems - Spikes in measurements	28
<b>Worked Example - Spot Welded VW Strain gauge</b>	<b>29</b>
<b>Temperature Calibration Factors</b>	<b>30</b>
<b>Adding a new thermistor type</b>	<b>30</b>
<b>Temperature Measurements</b>	<b>31</b>
Factory Set Steinhart Hart Calibration Factors	31
Testing the temperature measurements	31
22 Deg C fixed point - 3.3 K Ohm temperature test resistor	31
52 Deg C fixed point - 1 K Ohm temperature test resistor	31
<b>Sensor Problems and Diagnostics</b>	<b>32</b>
<b>Sensor Operating Characteristics</b>	<b>32</b>
VW strain gauge - Failed or loose weld	33
<b>APPENDIX-A</b>	<b>34</b>
Menu System Summary	34
Configuration Menu Options	35
Scanning Modes Menu	35
Auto-Logging Menu	36
<b>APPENDIX-B</b>	<b>37</b>
Sample Calibration Data Sheets	37
<b>Sample Vibrating wire Displacement Sensor Calibration Data Sheet</b>	<b>38</b>